

<b>E-M-HF5-V3_6</b>	Rotronic AG Bassersdorf, Switzerland
Document code	Unit
<b>HygroFlex HF5 Humidity Temperature Transmitters: User Guide</b>	<b>Instruction Manual</b>
	Document Type
Document title	Page 1 of 37

# HygroFlex HF5 Humidity Temperature Transmitters

## User Guide



<b>E-M-HF5-V3_6</b>	Rotronic AG Bassersdorf, Switzerland
Document code	Unit
<b>HygroFlex HF5 Humidity Temperature Transmitters: User Guide</b>	<b>Instruction Manual</b> Document Type
Document title	Page 2 of 37

## Table of contents

<b>1</b>	<b>Overview .....</b>	<b>3</b>
<b>2</b>	<b>Mechanical configurations and dimensions .....</b>	<b>4</b>
2.1	Supply voltage up to 40 VDC / 28 VAC (ABS housing) .....	4
2.2	Supply voltage up to 40 VDC / 28 VAC (Alu housing) .....	5
2.3	Supply voltage 100...240 VAC (ABS housing) .....	5
2.4	Models with USB or Ethernet interface .....	6
<b>3</b>	<b>General description.....</b>	<b>6</b>
3.1	Power supply options .....	6
3.2	Measured parameters .....	7
3.3	Calculated parameters .....	7
3.4	Analog output signals .....	7
3.5	Digital outputs .....	8
3.6	Service connector .....	8
3.7	Probe .....	8
3.8	HW4 software version compatibility .....	8
<b>4</b>	<b>User configurable settings and functions.....</b>	<b>8</b>
4.1	Function overview .....	9
4.2	Interaction between the HF5 and probe functions .....	10
4.3	Analog output signal type (except HF52).....	11
<b>5</b>	<b>Mechanical installation .....</b>	<b>11</b>
5.1	General guidelines .....	11
5.2	HF5 enclosure .....	12
5.3	Installation of the HF5 type W (surface mount).....	13
<b>6</b>	<b>Electrical installation .....</b>	<b>13</b>
6.1	General wiring guidelines .....	13
6.2	Guidelines for RS-485 wiring .....	15
6.3	Cable grip and cable specifications .....	15
6.4	Wiring .....	16
<b>7</b>	<b>Operation .....</b>	<b>27</b>
7.1	HF5 analog outputs .....	27
7.2	HF5 digital outputs .....	27
7.3	Display and keypad option .....	28
7.4	Internal menu (optional keypad and display) .....	28
7.5	Displayed parameters (optional keypad and display) .....	30
<b>8</b>	<b>Maintenance.....</b>	<b>30</b>
8.1	Service cable .....	30
8.2	Location of the service connector (mini USB type) .....	30
8.3	Periodic calibration check of the probe .....	31
8.4	Cleaning .....	32
8.5	Validation of the output signals transmission .....	32
8.6	Fuse .....	32
<b>9</b>	<b>Firmware updates.....</b>	<b>32</b>
<b>10</b>	<b>Technical data .....</b>	<b>33</b>
10.1	Specifications .....	33
10.2	Dew point accuracy .....	36
<b>11</b>	<b>Accessories .....</b>	<b>36</b>
<b>12</b>	<b>Supporting documents .....</b>	<b>36</b>
<b>13</b>	<b>Document releases .....</b>	<b>37</b>

<b>E-M-HF5-V3_6</b> Document code	Rotronic AG Bassersdorf, Switzerland Unit
<b>HygroFlex HF5 Humidity Temperature Transmitters: User Guide</b> Document title	<b>Instruction Manual</b> Document Type
	Page <b>3</b> of 37

## Applicability:

This manual applies to the following HF5 series transmitters:

- 2-wire loop powered models (HF52) with firmware version 3.0
- All other models with firmware version 2.x, where 2.x can be 2.0, 2.1, etc.

Changes to the last digit of the version number reflect minor firmware changes that do not affect the manner in which the instrument should be operated.

## 1 Overview

The HygroFlex HF5 transmitter series is designed for fixed installation in applications where high measurement accuracy is required and can be used with any of the HygroClip 2 plug-in probes.





The wide assortment of HygroClip 2 humidity-temperature probes can meet almost any application requirement. The HygroClip 2 probes feature well proven, durable sensors. Digital signal processing within the probe ensures consistent product performance and also facilitates the task of field maintenance with features such as potentiometer-free calibration, hot-swapping of the probe, etc.

Main features of the HF5 series:

- Interchangeable, plug-in HygroClip 2 probe (sold separately)
- Probe separation: up to 5 m / 16.4 ft (100 m / 330 ft with a digital signal booster)
- Relative humidity, temperature, dew point or other psychrometric parameter
- 0...100%RH and -100 to 200°C (-148 to 392°F) - depending on probe model
- Accuracy:  $\pm 0.8\%$ RH and 0.1°C / 0.2°F
- Analog outputs only, analog and digital outputs combined or digital outputs only
- User configurable settings
- Calculation of psychrometric parameters such as the dew or frost point
- Humidity temperature calibration and adjustment <sup>1)</sup>
- Simulator mode
- Automatic humidity sensor test and drift compensation <sup>1)</sup>
- Sensor failure mode <sup>1)</sup>
- Data recording <sup>1)</sup>

1) Except model HF52 (2-wire circuit type)

The ability for the user to easily update both the HF5 and HygroClip 2 probe firmware means that instruments of the HF5 series can be kept up-to-date regarding any future functionality improvement.

Symbol	Explanation
	Alternating current
	Protective Earth => Indicates a protective conductor terminal
	Warning! Electric Shock! Touching this part may cause a fatal electric shock. If physical contact is necessary while working, make sure that there is no dangerous voltage on the device.
	General warning Please see the relevant section in the manual when this symbol appears.

If the instructions in the manuals are not followed, the security of the equipment cannot be guaranteed.

<b>E-M-HF5-V3_6</b>	Rotronic AG Bassersdorf, Switzerland
Document code	Unit
<b>HygroFlex HF5 Humidity Temperature Transmitters: User Guide</b>	<b>Instruction Manual</b>
	Document Type
Document title	Page 4 of 37

## 2 Mechanical configurations and dimensions

Depending on the supply voltage, the HF5 uses three different sizes of enclosure

### 2.1 Supply voltage up to 40 VDC / 28 VAC (ABS housing)

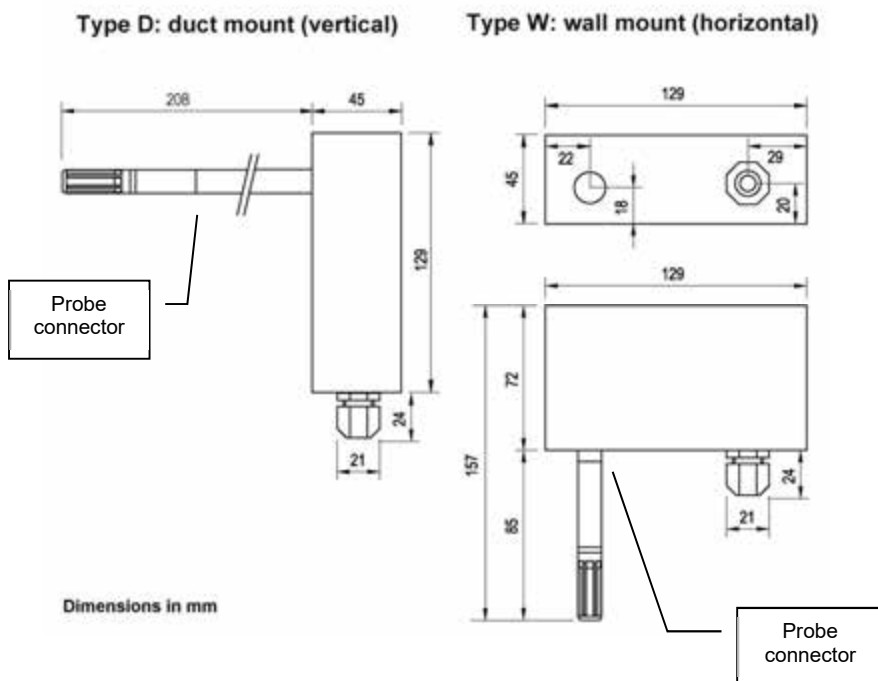

**NOTE:**

**Vertical mounting applies only to:**

- HF52 type D without keypad and display
- HF53 and HF54 type D without keypad and display or without digital option

**All other models are mounted horizontally**

<b>E-M-HF5-V3_6</b>	Rotronic AG Bassersdorf, Switzerland
Document code	Unit
<b>HygroFlex HF5 Humidity Temperature Transmitters: User Guide</b>	<b>Instruction Manual</b>
	Document Type
Document title	Page 5 of 37

## 2.2 Supply voltage up to 40 VDC / 28 VAC (Alu housing)

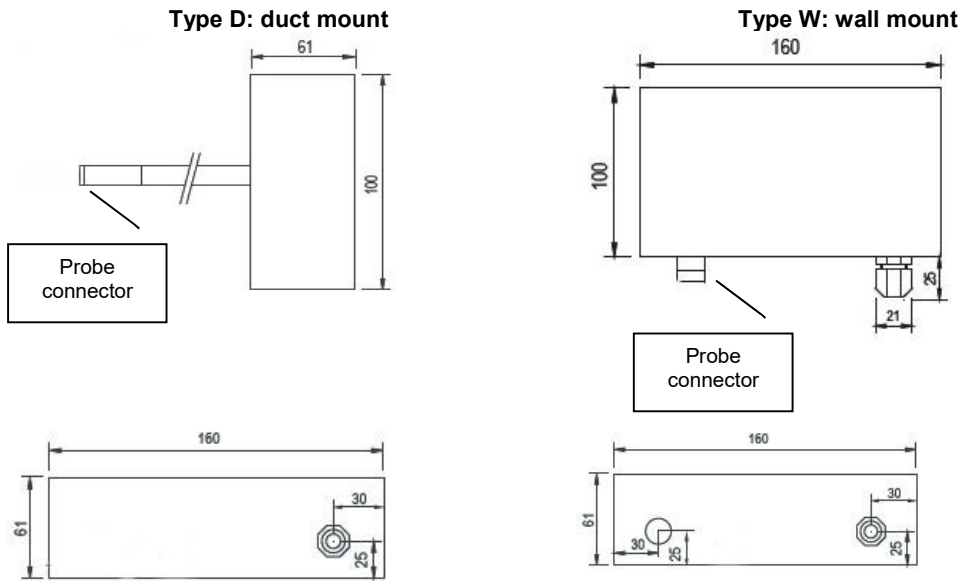

## 2.3 Supply voltage 100...240 VAC (ABS housing)

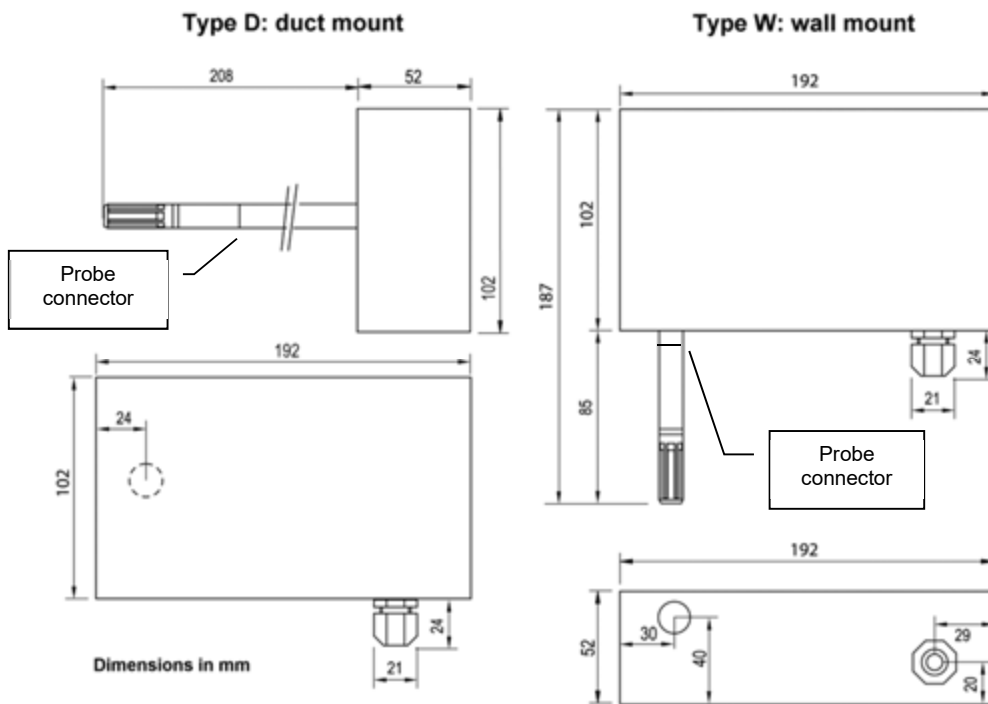

<b>E-M-HF5-V3_6</b>	Rotronic AG Bassersdorf, Switzerland
Document code	Unit
<b>HygroFlex HF5 Humidity Temperature Transmitters: User Guide</b>	<b>Instruction Manual</b> Document Type
Document title	Page <b>6</b> of 37

## 2.4 Models with USB or Ethernet interface

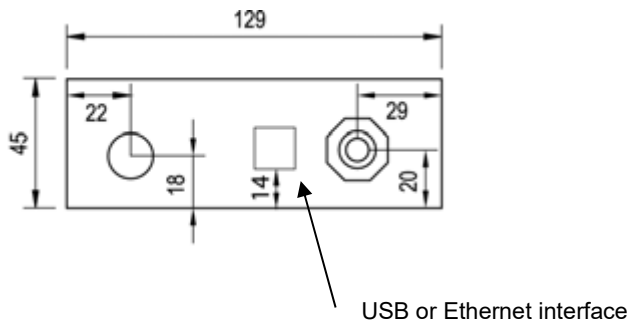

## 3 General description

It is important to comply with the manufacturer its instructions. If these instructions are not complied with, the safety characteristics of the HF5-device can be influenced.

### 3.1 Power supply options

Depending on the circuit type, the HF5 requires the following power supply:

- a) **HF52** (2-wire loop powered, analog outputs): 10...28 VDC - depending on the load connected to the output(s). The minimum supply voltage can be determined as follows:

$$V_{\min} = 10 \text{ V} + (0.02 \times \text{Load}^*) \quad * \text{Load resistance in } \Omega.$$

For the maximum load of 500  $\Omega$ , the minimum supply voltage is  $10 + (0.02 \times 500) = 20$  VDC. With both output circuits closed, the maximum current consumption is 40 mA.

- b) **HF53, HF54 and HF56** (3-wire, analog outputs optionally combined with a digital output):

- HF531/532/535: 18...40 VDC / 13...28 VAC
- HF533: 6...40 VDC / 13...28 VAC
- HF534: 10...40 VDC / 12...28 VAC
- HF54: 9...36 VDC / 7...24 VAC, galvanic isolation of the analog outputs and power supply
- HF56: 100...240 VAC, galvanic isolation of the analog outputs and power supply

HF53 and HF54: with both output circuits closed, the typical current consumption is 100 mA.

HF56: typical current consumption <50 mA at 100 VAC and <35 mA at 240 VAC

Please verify the product identification label to determine which power supply option is installed on your transmitter.

- c) **HF556, HF557 and HF566** (digital output only):

- HF556: 5...40 VDC / 12...28 VAC
- HF557: PoE (power over Ethernet). The HF557 is not available with a RS-485 interface and can be powered only via a LAN.
- HF566: 100...240 VAC

Typical current consumption

<b>E-M-HF5-V3_6</b> Document code	Rotronic AG Bassersdorf, Switzerland Unit
<b>HygroFlex HF5 Humidity Temperature Transmitters: User Guide</b> Document title	<b>Instruction Manual</b> Document Type
	Page 7 of 37

HF556 with USB interface : 100 mA  
 HF556 with Ethernet (TCP/IP) interface and HF557 : 300 mA  
 HF566 with Ethernet (TCP/IP) interface : <50 mA at 100 VAC and <35 mA at 240 VAC

### 3.2 Measured parameters

A HygroClip 2 from Rotronic has to be used with the HF5 transmitter. The HygroClip 2 probe together with the HF5 transmitter measures relative humidity with a ROTRONIC Hygromer® IN1 capacitive sensor and temperature with a Pt100 RTD.

### 3.3 Calculated parameters

Using the ROTRONIC HW4 software, the HF5 can be configured by the user to calculate one of the following parameters:

- Dew point (Dp) above and below freezing
- Frost point (Fp) below freezing and dew point above freezing
- Wet bulb temperature (Tw)
- Enthalpy (H)
- Vapor concentration (Dv)
- Specific humidity (Q)
- Mixing ratio by weight (R)
- Vapor concentration at saturation (Dvs)
- Vapor partial pressure (E)
- Vapor saturation pressure (Ew)

Note: some of the above parameters depend on the value of the barometric pressure. Using the ROTRONIC HW4 software, a fixed barometric pressure value can be specified. For instructions see the following HW4 manual: **E-M-HW4v3-F2-005**

### 3.4 Analog output signals

#### Parameter:

With the ROTRONIC HW4 software any of the two analog output signals can be made to correspond to one of the following:

- Relative humidity
- Temperature
- Calculated parameter

Any output can also be disabled.

#### Output Scale:

The scale of each analog output can be set within the numerical limits of -999.99 and 9999.99. The D/A converters used to generate the analog output signals feature a 16-bit resolution.

#### Signal Type:

Both analog outputs provide the same type of signal. With the exception of the HF52 (always 4...20 mA), the type of signal can be selected with the ROTRONIC HW4 software to any of the following:

Current output: 0...20 mA, 4...20 mA (up to 15 V)  
 Voltage output: 0...1V, 0...5V or 0...10V (see 4.3).

<b>E-M-HF5-V3_6</b> Document code	Rotronic AG Bassersdorf, Switzerland Unit
<b>HygroFlex HF5 Humidity Temperature Transmitters: User Guide</b> Document title	<b>Instruction Manual</b> Document Type
	Page <b>8</b> of 37

### 3.5 Digital outputs

Models with a digital output can simultaneously transmit 3 parameters: relative humidity, temperature and calculated parameter

#### a) RS-485 serial interface

Some models of the HF5 are equipped with a RS-485 serial interface. This can be used to connect together up to 64 devices in a multi-dropped arrangement. In principle, an unlimited number of such networks can be monitored with the HW4 software, but each RS-485 multi-drop network is limited to 64 devices. The HF5 can be used either as a slave or a master, without special configuration. The master is automatically the device that is directly connected to a PC by means of a USB port or Ethernet (TCP/IP) port.

**RS-485 Compatibility:** The communication protocol used by the HF5 and other AirChip 3000 products is not compatible with the protocol used by the previous generation of ROTRONIC instruments. Do not connect legacy products and AirChip 3000 products to the same RS-485 multi-drop network.

#### b) USB or Ethernet interface

Some models of the HF5 are available with a USB or Ethernet client interface in addition to the RS-485 interface. In this case the protection grade of the HF5 enclosure is no longer IP65 / NEMA 4 rated.

### 3.6 Service connector

The client service connector is a UART digital interface (Universal Asynchronous Receiver Transmitter) with a mini-USB type connector. This allows connecting the HF5 with a service cable to a PC running the ROTRONIC HW4 software. See "Maintenance" for the location of the service connector and for the type of service cable to be used. The service connector is used to configure the HF5 and to update its firmware with the HW4 software.

**Note:** any digital output (USB, Ethernet and RS-485) offers the same functionality as the service connector.

### 3.7 Probe

The HF5 is compatible with all available models of HygroClip 2 probes. For detailed information on the probes see document **E-M-HC2 Probes-V1**.

### 3.8 HW4 software version compatibility

The HF5 version 2 requires HW4 version 3.0.0 or higher for full functionality of the Device Manager function.

## 4 User configurable settings and functions

The HF5 ships configured as specified on the customer order. Models with analog outputs only can be installed and used just as any conventional humidity and temperature transmitter and most users will never need to use the HF5 configurable settings and functions. Models with a digital output generally require some configuration by the user.

Making use of the HF5 and probe configurable settings and functions is entirely up to the user and the appropriate settings depend on the user application. We have provided below a short description of the HF5 and probe functions and also indicated the factory default settings.



<b>E-M-HF5-V3_6</b> Document code	Rotronic AG Bassersdorf, Switzerland Unit
<b>HygroFlex HF5 Humidity Temperature Transmitters: User Guide</b> Document title	<b>Instruction Manual</b> Document Type Page 9 of 37

#### 4.1 Function overview

MEASUREMENT ACCURACY AND RELIABILITY (PROBE FUNCTIONS)	
AirChip 3000 Functions	Description
▶ Humidity / temperature adjustment	<ul style="list-style-type: none"> <li>○ 1-point or multi-point humidity calibration or adjustment</li> <li>○ 1-point or 2-point temperature calibration or adjustment</li> <li>○ Generate a time stamp for calibrations and adjustments</li> <li>○ Retain and view last adjustment date and adjustment values</li> <li>○ Generate calibration and adjustment protocols</li> </ul>
▶ Automatic humidity sensor test and optional drift compensation	<p>Tests the humidity sensor for drift caused by contaminants and can be used to automatically apply a correction. The test is automatically carried out at regular intervals of time. Can be configured, enabled, or disabled</p> <p>The humidity sensor status can be verified either with the HW4 software or with the instrument display (if available) and is shown as Good, SQ-tuned (corrected for drift) or Bad (defective)</p> <p><b>Not available when the probe is connected to a HF52</b></p>
▶ Data recording	<p>The data recording function differs from a true data logging function in the sense that the AirChip 3000 does not time stamp the data. The data recording function can be used to investigate events such as a sensor malfunction as well as to retrieve data that would otherwise be lost</p> <ul style="list-style-type: none"> <li>○ Start or stop data recording - up to 2000 value pairs (%RH and temperature). Starting a recording session erases all previously recorded data</li> <li>○ The recording mode and log interval can be specified</li> <li>○ When the device is powered off, the recording session is paused but not ended. As long as the recording session has not been ended, the device automatically resumes recording data when powered up again</li> <li>○ The recorded data can be downloaded to a PC with the HW4 software, time stamped and viewed</li> </ul> <p><b>Not available when the probe is connected to a HF52</b></p>

MEASUREMENT LOOP VALIDATION	
Functions	Description
▶ Simulator mode	Used to make the HF5 generate fixed values for the humidity, temperature and calculated parameter. Can be configured, enabled or disabled

DEVICE SAFEGUARDS	
Functions	Description
▶ Device write protection	Used to protect the HF5 with a password to prevent unauthorized digital access by a digital user. Can be configured, enabled or disabled
▶ Internal menu access from keypad	Used to prevent accidental changes to the HF5 settings and temperature-humidity adjustment by disabling the MENU key on the optional keypad. Can be enabled or disabled

<b>E-M-HF5-V3_6</b> Document code	Rotronic AG Bassersdorf, Switzerland Unit
<b>HygroFlex HF5 Humidity Temperature Transmitters: User Guide</b> Document title	<b>Instruction Manual</b> Document Type Page 10 of 37

PROCESS PROTECTION AND PROTECTION OF OTHER DEVICES	
AirChip 3000 Functions	Description
▶ Limit humidity output to 100 %RH	This probe function is used to prevent the humidity signal from exceeding 100 %RH when condensation forms on the sensor. Can be enabled or disabled
▶ Out-of-limit value alarm	Used to specify the normal range for humidity, temperature and the calculated parameter depending on the user application. Can be configured, enabled or disabled  Out-of-limit values trigger a digital alarm which can be also be seen on the optional display
▶ Bad sensor alarm	This is a built-in probe function. Cannot be disabled  A bad humidity or temperature sensor triggers a digital alarm which can be also be seen on the optional HF5 display provided that the HF5 is set to monitor probe alarms
▶ Fail safe mode	Used to specify a "safe" fixed value for humidity and for temperature (HF5 or probe) in the event of: <ul style="list-style-type: none"> <li>○ Loss of communication with the probe (HF5 function)</li> <li>○ Sensor failure (probe function)</li> </ul> Can be configured, enabled or disabled

## 4.2 Interaction between the HF5 and probe functions

It is important to note that when used together, the HF5 transmitter and HC2 probe (HygroClip 2) constitute a 2-component system. Each system component has its own microprocessor, firmware and functions. Some of these functions are unique to each system component. Other functions are found in both components.

**HF52** (2-wire, loop powered transmitter): due to the necessity of limiting the current consumption of the combination of HF52 and HC2 probe to less than 4 mA, several probe functions such as RH sensor test, data recording and probe adjustment are not available with the HF52.

The functions and settings of the HF5 transmitter and HygroClip 2 probe (HC2) operate together as indicated below:

Function / Setting	HF5	HC2	Notes
Device protection	X	X	Individual to the HF5 and HC2 probe
RS-485 address	X	X	Individual to the HF5 and HC2 probe
Device Name	X	X	User defined description The device name of the HC2 probe is not displayed by HW4 and is replaced with the HF5 Input Name
Calculation	X	X	Psychrometric calculation HF5 setting overrides HC2 probe setting
Data refresh rate	X		Depending on the model, the data refresh rate is as follows:  HF52: typically 20 s Other models: typically 1 s
Simulator function	X	X	Generates fixed humidity and / or temperature value When enabled, the HF5 settings override the HC2 probe settings

<b>E-M-HF5-V3_6</b> Document code	Rotronic AG Bassersdorf, Switzerland Unit
<b>HygroFlex HF5 Humidity Temperature Transmitters: User Guide</b> Document title	<b>Instruction Manual</b> Document Type Page 11 of 37

Function / Setting	HF5	HC2	Notes
Unit system	X	X	The HF5 setting overrides HC2 probe setting regarding the HF5 signals. The HC2 probe settings still apply when the probe is used alone  <b>Make sure to use the same humidity symbol and the same temperature unit for both the HF5 and probe.</b>
Out-of-limits value alarm	X	X	The HF5 settings are independent from the HC2 probe settings.  The HC2 probe settings have an effect only when the HF5 is enabled to monitor alarms generated by the probe  When out-of-limit values have been defined for the same parameter for both the HF5 and probe, any alarm is triggered based on the narrowest set of limits (assuming that the HF5 has been set to monitor probe alarms).
Analog outputs	X	X	Parameter and scale The HC2 probe settings have no effect on the HF5

### 4.3 Analog output signal type (except HF52)

Both analog outputs of the HF5 provide the same type of signal. With the exception of the HF52 (always 4...20 mA), the type of signal can be selected with the ROTRONIC HW4 software to any of the following: 0...20 mA, 4...20 mA, 0...1V, 0...5V or 0...10V. To select the analog signal type proceed as follows:

- Use the appropriate model of service cable (see Maintenance > Service Cable) to connect the service connector of the HF5 to a USB port of a PC with the HW4 software installed (HW4 3.0.0 or higher). Note that the ROTRONIC USB driver must be installed on the PC as explained in the HW4 manual **E-M-HW4v3-Main**
- Start HW4 on the PC and search for the HF5 (HW4 Main Menu Bar > Devices and Groups > Search for USB Masters).
- After finding the HF5 with HW4, expand the device tree to see the HF5 functions. Select Device Manager.
- For further instructions see HW4 manual **E-M-HW4v3-F2-005**

No adjustment is required after changing the type of output signal.

## 5 Mechanical installation

### 5.1 General guidelines

Relative humidity is extremely dependent on temperature. Proper measurement of relative humidity requires that the probe and its sensors be at exactly the temperature of the environment to be measured. Because of this, the location where you choose to install the probe can have a significant effect on the performance of the instrument. The following guidelines should guarantee good instrument performance:

- Select a representative location:** install the probe where humidity, temperature and pressure conditions are representative of the environment to be measured.
- Provide good air movement at the probe:** air velocity of at least 200 ft/ minute (1 meter/second) facilitates adaptation of the probe to changing temperature.
- Avoid the following:** (1) Close proximity of the probe to a heating element, a cooling coil, a cold or hot wall, direct exposure to sun rays, etc. (2) Close proximity of the probe to a steam injector,

<b>E-M-HF5-V3_6</b> Document code	Rotronic AG Bassersdorf, Switzerland Unit
<b>HygroFlex HF5 Humidity Temperature Transmitters: User Guide</b> Document title	<b>Instruction Manual</b> Document Type
	Page 12 of 37

humidifier, direct exposure to precipitation, etc. (3) Unstable pressure conditions resulting from excessive air turbulence.

- d) **Immerse as much of the probe as possible in the environment to be measured.**
- e) **Prevent the accumulation of condensation water at the level of the sensor leads.** Install the probe so that the probe tip is looking downward. If this is not possible, install the probe horizontally.

## 5.2 HF5 enclosure

The HF5 enclosure consists of a base and a cover held together with 4 screws. To open the enclosure, use a metric 2.5 mm or 3 mm hex key. Prior to re-assembling the enclosure, verify that the red seal is sitting properly in its groove on the base. Installation of the HF5 type D (through wall mount)

### Mounting position of the enclosure

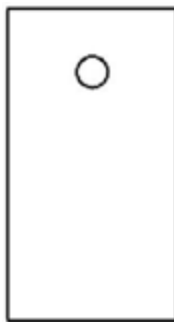

#### Vertical:

- HF52 type D without keypad and display
- HF53 and HF54 type D without keypad and display, and without digital option

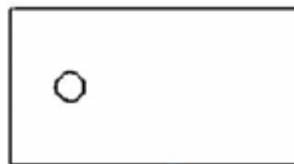

#### Horizontal:

- HF52 type D with keypad and display
- HF53, HF54 type D with keypad and display or with digital option
- All other type D models

### Mounting hardware



The **QMA-15** consists of a flange and compression fitting and is designed to hold the probe of the HF5 type D when mounted through a wall (see Accessories). The HF5 does not require any additional support.

<b>E-M-HF5-V3_6</b> Document code	Rotronic AG Bassersdorf, Switzerland Unit
<b>HygroFlex HF5 Humidity Temperature Transmitters: User Guide</b> Document title	<b>Instruction Manual</b> Document Type
	Page 13 of 37

### 5.3 Installation of the HF5 type W (surface mount)

#### *Mounting position of the enclosure*

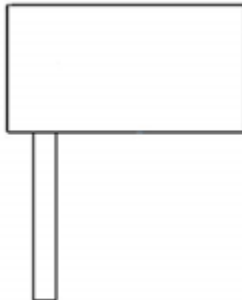

**Horizontal:**

HF52, HF53, HF54, HF55 and HF56 type W

#### *Mounting hardware*

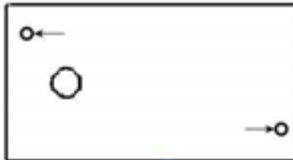

**Method 1:** The HF5 is supplied with 2 screws, 2 drywall anchors and two rubber washers. The base of the enclosure has 2 screw-wells (see drawing) that are normally closed at the bottom. Use the template provided with the HF5 to drill mounting holes in the wall and insert the drywall anchors. Place a rubber washer on each screw. Insert a screw in each well and push to open the bottom of the well.



**Method 2:** When a DIN-rail (35 mm / 1 3/8 ") is available use part **AC5002** (not included). This is a DIN-rail mounting kit consisting of 2 clamps that attach to the back of the enclosure with the screws provided.

## 6 Electrical installation

The safety of the installed system, where the device is integrated, is the responsibility of the builder of the system.

### 6.1 General wiring guidelines

#### *Power supply wiring*

Heavy machinery and instrumentation should not share the same power supply wiring. If this cannot be avoided, noise filters and surge protectors should be used. Most UPS devices have those features already integrated.

#### *Electrical Safety Warning (HF56x)*

The HF5 transmitter series includes models designed to operate with a supply voltage of 100...240 VAC. For safety reasons, the electrical installation of these models must be designed providing an adequate protection. A form of an external circuit breaker, switch, fuse or other can be used to separate the transmitter from the supply voltage. Appropriate safety warnings and instructions must be located by the transmitter in order to prevent electrical shock with open transmitter enclosure.

<b>E-M-HF5-V3_6</b> Document code	Rotronic AG Bassersdorf, Switzerland Unit
<b>HygroFlex HF5 Humidity Temperature Transmitters: User Guide</b> Document title	<b>Instruction Manual</b> Document Type
	Page <b>14</b> of 37

The guarantee of the security of the whole system which includes the HF5 is the responsibility of the developer of the system.

Ensure that the cable gland is tightened so that this is not detachable by hand.

The electrical installation of the device must be performed by a qualified electrician and correspond with IEC (International Electrotechnical Commission) requirements.

It is important to ensure, to use a suitable mains cable:

- Voltage Range min. 240 VAC
- Cable cross-section : 6 ... 8 mm
- Max Wire cross : 2.5 mm<sup>2</sup>
- Recommended : 3x075mm<sup>2</sup> H05VV-F Cable
- Specify torque: 3-5 Nm

**General guidelines for signal cables**

The following guidelines are derived from International Standard IEC 61158 / IEC 61784 for the transmission of signals by copper wires. When planning an installation, the rules provided by IEC 61158 / IEC 61784 should be followed under consideration of local circumstances to determine the position of machines and equipment.

Whenever the level of electromagnetic interference is expected to be high, both the instruments and signal cables should be placed as far away as possible from the source of interference. In general, signal cables should be installed in bundles or channels / conduits, separate from other cables as indicated in the table below:

<ul style="list-style-type: none"> <li>• Bus signals such as RS485</li> <li>• Data signals for PCs, printers etc.</li> <li>• shielded analog inputs</li> <li>• unshielded direct current (&lt;= 60V)</li> <li>• shielded process signals (&lt;= 25 V)</li> <li>• unshielded alternate current (&lt;= 25V)</li> <li>• coaxial cables for CRT monitors</li> </ul>	<b>in common bundles or channels / conduits</b>
<ul style="list-style-type: none"> <li>• direct current from 60 V to 400 V (unshielded)</li> <li>• alternate current from 25V to 400 V (unshielded)</li> </ul>	<b>in separated bundles or channels / conduits, without minimum distance /</b>
<ul style="list-style-type: none"> <li>• direct and alternate current &gt; 400 V (unshielded)</li> <li>• Telephone lines</li> <li>• lines leading into EX-rated areas</li> </ul>	<b>in separated bundles or channels / conduits, without minimum distance</b>

<b>E-M-HF5-V3_6</b> <small>Document code</small>	Rotronic AG Bassersdorf, Switzerland <small>Unit</small>
<b>HygroFlex HF5 Humidity Temperature Transmitters: User Guide</b> <small>Document title</small>	<p style="text-align: right;"><b>Instruction Manual</b> <small>Document Type</small></p> <p style="text-align: center;">Page <b>15</b> of 37</p>

### ***Lightning protection***

Cabling in areas with a risk of lightning requires a lightning protection. For cabling underground in between buildings, we recommend the use of special fiber optic cables. If this is not possible, use copper cables that are suitable for underground installation.

### **6.2 Guidelines for RS-485 wiring**

See document **E-DV04-RS485.01**: RS485 Network Installation and Start-up Guidelines

### **6.3 Cable grip and cable specifications**

Depending on the model, the HF5 is supplied either with one or two M16 sealing cable grips or with one or two 1/2" conduit adapters. The M16 cable grip provides effective sealing only with cables having the proper outside diameter. Preferably, use a cable with an outside diameter of 6 to 8 mm (0.236 to 0.314 inch) with 18 AWG wires.

<b>E-M-HF5-V3_6</b>	Rotronic AG Bassersdorf, Switzerland
Document code	Unit
<b>HygroFlex HF5 Humidity Temperature Transmitters: User Guide</b>	<b>Instruction Manual</b>
Document title	Document Type
	Page 16 of 37

## 6.4 Wiring

### HF52: 2-wire, loop powered transmitter

#### Electrical diagram

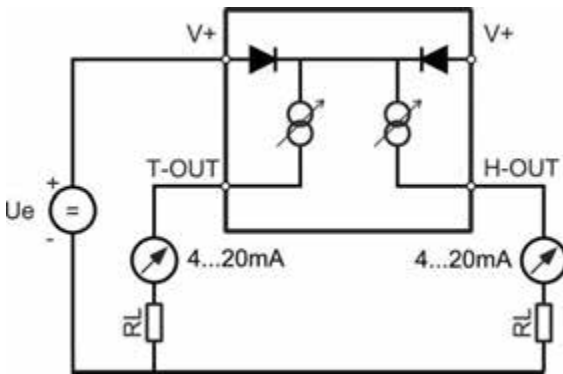

The maximum permissible cable length connecting the HF52 to other devices is determined by the total resistance resulting from the addition of the cable resistance and that of the devices connected in series with the unit.

This resistance should not exceed 500 Ω.

#### Terminal block diagram

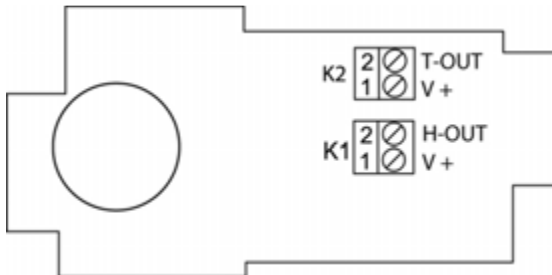

Terminals	Description
K2-2: T-OUT	Temperature output (+) OUT-2
K2-1: V+	Power supply: 10...28 VDC (+)

Terminals	Description
K1-2: H-OUT	Relative humidity or dew point (+) OUT-1
K1-1: V+	Power supply: 10...28 VDC (+)

**Note:** connect the + of the power supply to only one of the V+ terminals. The two terminals marked V+ are internally connected.

#### Measuring humidity or temperature only

Operation of the HF52 does not require both current loops to be closed. When using the HF52 to measure either humidity only or temperature only, close only the loop that is being used.

Using the ROTRONIC HW4 software, any unused output of the HF52 can be disabled.



<b>E-M-HF5-V3_6</b>	Rotronic AG Bassersdorf, Switzerland
Document code	Unit
<b>HygroFlex HF5 Humidity Temperature Transmitters: User Guide</b>	<b>Instruction Manual</b>
Document title	Document Type
	Page 17 of 37

**HF53: 3-wire transmitter**

**Electrical diagram for voltage outputs**

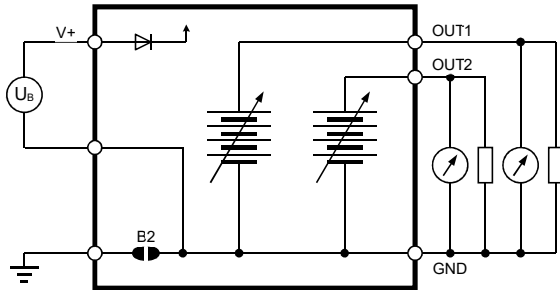

The maximum permissible cable length can be determined under consideration of the voltage drop caused by the current flowing to the devices connected to the unit. The voltage drop in the cable depends both on cable resistance and on the equivalent resistance of the devices connected in parallel to the unit. The total resistance connected to each unit output should be at least 1000 Ω. Cable resistance should not be more than 1/1000 of the load resistance.

**Electrical diagram for current outputs**

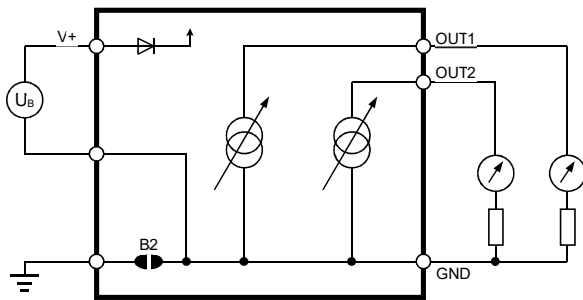

The maximum permissible cable length, connecting the unit to other devices, is determined by the total resistance resulting from the addition of the cable resistance and that of the devices connected in series with the unit. This resistance should not exceed 500 Ω.

**Terminal block diagram (analog outputs only)**

Type D and W (horizontal mount)

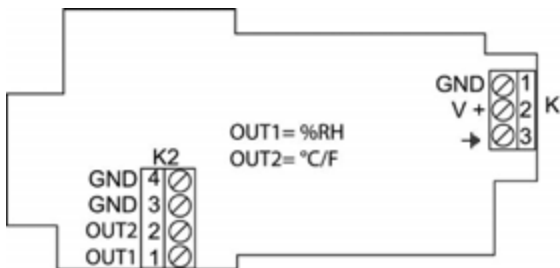

Terminals	Description
K1-1: V-	Power supply (-) or neutral
K1-2: V+	Power supply: 18...40 VDC (+) or 12...28 VAC (Phase)
K1-3:	Protective ground (see note below)

Terminals	Description
K2-4: GND	Ground (tied with other GND)
K2-3: GND	Ground (tied with other GND)
K2-2: OUT2	Temperature output (+)
K2-1: OUT1	Relative humidity or dew point (+)

<b>E-M-HF5-V3_6</b>	Rotronic AG Bassersdorf, Switzerland
Document code	Unit
<b>HygroFlex HF5 Humidity Temperature Transmitters: User Guide</b>	<b>Instruction Manual</b> Document Type
Document title	Page 18 of 37

Type D (vertical mount)

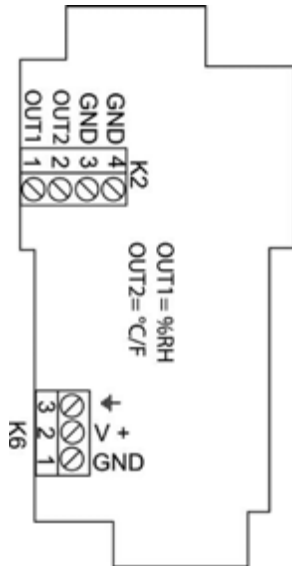

Terminals	Description
K2-4: GND	Ground (tied with other GND)
K2-3: GND	Ground (tied with other GND)
K2-2: OUT2	Temperature output (+)
K2-1: OUT1	Relative humidity or dew point (+)

Terminals	Description
K6-1: V-	Power supply (-) or neutral
K6-2: V+	Power supply: 18...40 VDC (+) or 12...28 VAC (Phase)
K6-3: 	Protective ground (see note below)

**Note:** Terminals K1-3 or K6-3 (protective or earth ground) are tied with GND. If this is not wanted, a land (B18) on the PCB must be removed.

<b>E-M-HF5-V3_6</b>	Rotronic AG Bassersdorf, Switzerland
Document code	Unit
<b>HygroFlex HF5 Humidity Temperature Transmitters: User Guide</b>	<b>Instruction Manual</b>
Document title	Document Type
	Page 19 of 37

**Terminal block diagram (analog outputs and digital option)**

Type D and W (horizontal mount)

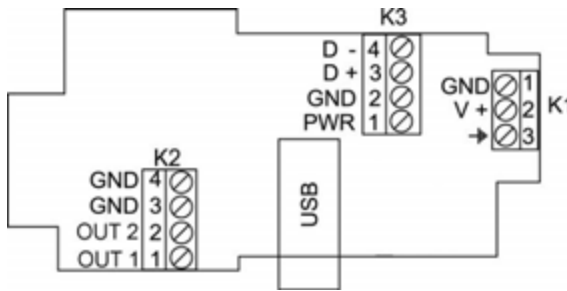

Terminals	Description
K1-1: V-	Power supply (-) or neutral
K1-2: V+	Power supply: 18...40 VDC (+) or 12...28 VAC (Phase)
K1-3:	Protective ground (see note below)

Terminals	Description
K2-4: GND	Ground (tied with other GND)
K2-3: GND	Ground (tied with other GND)
K2-2: OUT2	Temperature output (+)
K2-1: OUT1	Relative humidity or dew point (+)

Terminals	Description
K3-4: D-	RS-485 Bi-directional TX- / RX -
K3-3: D+	RS-485 Bi-directional TX+ / RX +
K3-2: GND	Ground / Power supply (-)
K3-1: PWR	DC (+) 15...24 VDC (+) (optional, see note below)

**Notes:**

**Terminal K1-3:** this terminal (protective or earth ground) is tied with GND. If this is not wanted, a land (B18) on the PCB must be removed.

**Terminal block K3 (RS-485):** terminals K3-1 and K3-2 can be used to power the HF53 from a 15 to 24 VDC power supply connected to the RS-485 main data line. In this case, do not use terminals K1-1 and pin K1-2 (normally used to power the HF53).

**USB or TCP/IP port:** this port is optional

**Measuring humidity or temperature only**

Operation of the HF53 does not require both current loops to be closed. When using the HF53 to measure either humidity only or temperature only, close only the loop that is being used.

Using the ROTRONIC HW4 software, any unused output of the HF53 can be disabled.

<b>E-M-HF5-V3_6</b>	Rotronic AG Bassersdorf, Switzerland
Document code	Unit
<b>HygroFlex HF5 Humidity Temperature Transmitters: User Guide</b>	<b>Instruction Manual</b>
Document title	Document Type
	Page 20 of 37

**HF54: 3-wire transmitter, galvanic isolation of the analog outputs**

**Electrical diagram for voltage outputs**

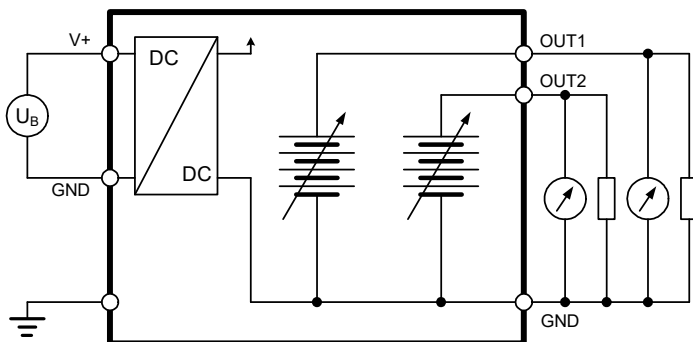

The maximum permissible cable length can be determined under consideration of the voltage drop caused by the current flowing to the devices connected to the unit. The voltage drop in the cable depends both on cable resistance and on the equivalent resistance of the devices connected in parallel to the unit. The total resistance connected to each unit output should be at least  $1000 \Omega$ . Cable resistance should not be more than  $1/1000$  of the load resistance.

**Electrical diagram for current outputs**

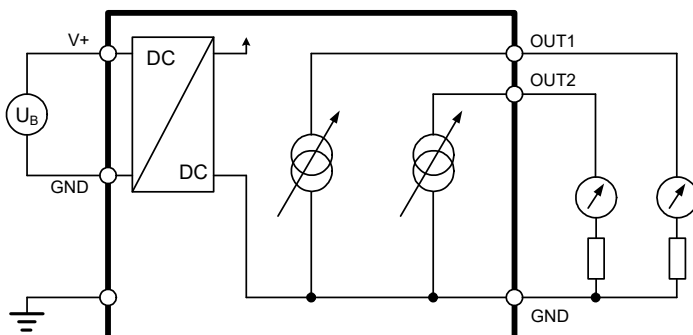

The maximum permissible cable length, connecting the unit to other devices, is determined by the total resistance resulting from the addition of the cable resistance and that of the devices connected in series with the unit. This resistance should not exceed  $500 \Omega$ .

**Terminal block diagram (analog outputs only)**

<b>E-M-HF5-V3_6</b>	Rotronic AG Bassersdorf, Switzerland
Document code	Unit
<b>HygroFlex HF5 Humidity Temperature Transmitters: User Guide</b>	<b>Instruction Manual</b>
Document title	Document Type
	Page <b>21</b> of 37

Type D and W (horizontal mount)

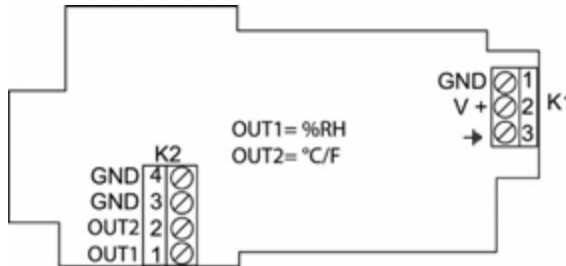

Terminals	Description
K1-1: V-	Power supply (-) or neutral
K1-2: V+	Power supply: 18...40 VDC (+) or 12...28 VAC (Phase)
K1-3:	Protective ground (see note below)

Terminals	Description
K2-4: GND	Ground (tied with other GND)
K2-3: GND	Ground (tied with other GND)
K2-2: OUT2	Temperature output (+)
K2-1: OUT1	Relative humidity or dew point (+)

Type D (vertical mount)

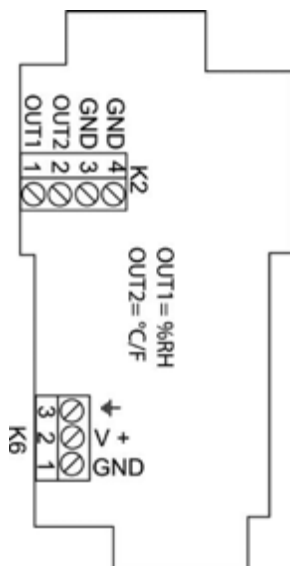

Terminals	Description
K2-4: GND	Ground (tied with other GND)
K2-3: GND	Ground (tied with other GND)
K2-2: OUT2	Temperature output (+)
K2-1: OUT1	Relative humidity or dew point (+)

**Note:** Terminals K1-3 or K6-3 (protective or earth ground) are tied with GND. If this is not wanted, a land (B18) on the PCB must be removed.

Terminals	Description
K6-1: V-	Power supply (-) or neutral
K6-2: V+	Power supply: 18...40 VDC (+) or 12...28 VAC (Phase)
K6-3: ⚡	Protective ground (see note below)

<b>E-M-HF5-V3_6</b>	Rotronic AG Bassersdorf, Switzerland
Document code	Unit
<b>HygroFlex HF5 Humidity Temperature Transmitters: User Guide</b>	<b>Instruction Manual</b>
Document title	Document Type
	Page 22 of 37

**Terminal block diagram (analog outputs and digital option)**

Type D and W (horizontal mount)

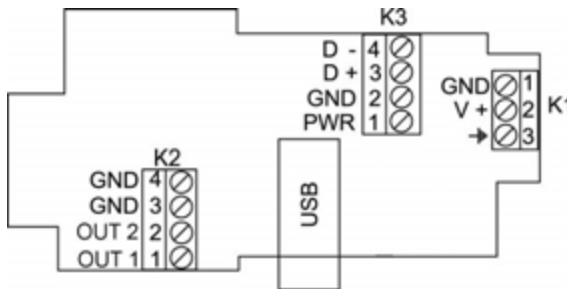

Terminals	Description
K1-1: V-	Power supply (-) or neutral
K1-2: V+	Power supply: 18...40 VDC (+) or 12...28 VAC (Phase)
K1-3:	Protective ground (see note below)

Terminals	Description
K2-4: GND	Ground (tied with other GND)
K2-3: GND	Ground (tied with other GND)
K2-2: OUT2	Temperature output (+)
K2-1: OUT1	Relative humidity or dew point (+)

Terminals	Description
K3-4: D-	RS-485 Bi-directional TX- / RX -
K3-3: D+	RS-485 Bi-directional TX+ / RX +
K3-2: GND	Ground
K3-1: PWR	Not used

**Notes:**

**Terminal K1-3:** this terminal (protective or earth ground) is tied with GND. If this is not wanted, a land (B18) on the PCB must be removed.

**USB or TCP/IP port:** this port is optional

**Measuring humidity or temperature only**

Operation of the HF54 does not require both current loops to be closed. When using the HF54 to measure either humidity only or temperature only, close only the loop that is being used.

Using the ROTRONIC HW4 software, any unused output of the HF54 can be disabled.

<b>E-M-HF5-V3_6</b>	Rotronic AG Bassersdorf, Switzerland
Document code	Unit
<b>HygroFlex HF5 Humidity Temperature Transmitters: User Guide</b>	<b>Instruction Manual</b>
	Document Type
Document title	Page <b>23</b> of 37

### HF556: digital output

#### Connectors and terminal block diagram

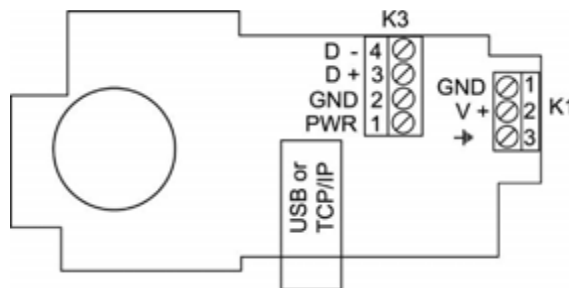

Terminals	Description
K1-1: V-	Power supply (-) or neutral
K1-2: V+	Power supply: 5...40 VDC (+) or 12...28 VAC (Phase)
K1-3: ⚡	Protective ground (see note below)

Terminals	Description
K3-4: D-	RS-485 Bi-directional TX- / RX -
K3-3: D+	RS-485 Bi-directional TX+ / RX +
K3-2: GND	Ground / Power supply (-) (tied with other GND)
K3-1: PWR	DC (+) 15...24 VDC (+) (optional, see note below)

#### Notes:

**Terminal K1-3:** this terminal (protective or earth ground) is tied with GND. If this is not wanted, a land (B18) on the PCB must be removed.

**Terminal block K3 (RS-485):** terminals K3-1 and K3-2 can be used to power the HF55 from a 15 to 24 VDC power supply connected to the RS-485 main data line. In this case, do not use terminals K1-1 and pin K1-2 (normally used to power the HF55).

**WARNING:** Connecting a device to an active Ethernet network can disrupt communications on the network. Before connecting the HF5, make sure that it is properly configured for your network.

<b>E-M-HF5-V3_6</b> Document code	Rotronic AG Bassersdorf, Switzerland Unit
<b>HygroFlex HF5 Humidity Temperature Transmitters: User Guide</b> Document title	<b>Instruction Manual</b> Document Type
	Page <b>24</b> of 37

**HF557: digital output, PoE (power over Ethernet)**

This model is powered from the Ethernet LAN and has no terminal blocks.

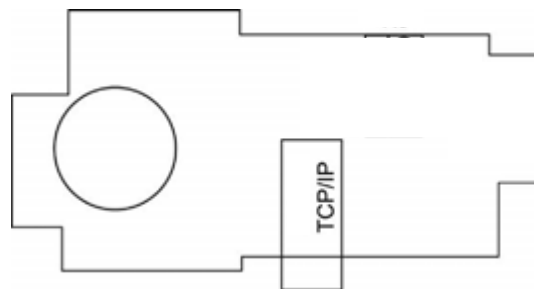

**WARNING:** Connecting a device to an active Ethernet network can disrupt communications on the network. Before connecting the HF5, make sure that it is properly configured for your network.

**HF56: 100...240 VAC supply voltage**

*Electrical diagram for voltage outputs*

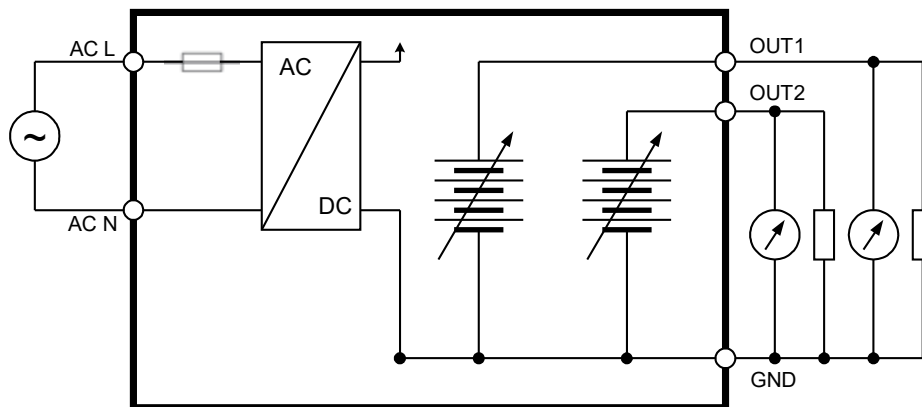

The maximum permissible cable length can be determined under consideration of the voltage drop on the cable.

The voltage drop in the cable depends both on cable resistance and on the equivalent resistance of the devices connected in parallel to the unit.

The total resistance connected to each unit output has to be at least 1000 Ω.

Cable resistance should not be more than 1/1000 of the load resistance.



<b>E-M-HF5-V3_6</b> Document code	Rotronic AG Bassersdorf, Switzerland Unit
<b>HygroFlex HF5 Humidity Temperature Transmitters: User Guide</b> Document title	<b>Instruction Manual</b> Document Type Page <b>25</b> of 37

**Electrical diagram for current outputs**

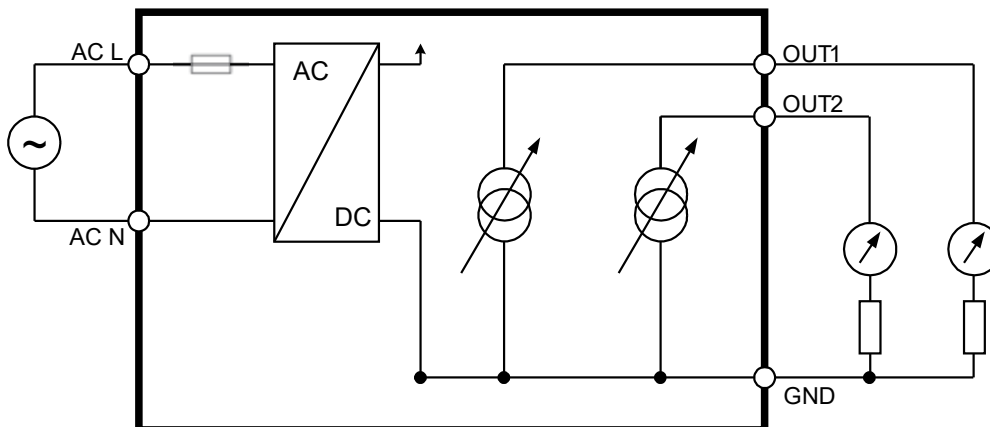

The maximum permissible cable length, connecting the unit to other devices, is determined by the total resistance (cable resistance + devices connected in series with the unit). This resistance should not exceed 500  $\Omega$ .

**Measuring humidity or temperature only**

Operation of the HF56 does not require both current loops to be closed. When using the HF56 to measure either humidity only or temperature only, close only the loop that is being used.

Using the ROTRONIC HW4 software, any unused output of the HF56 can be disabled.

<b>E-M-HF5-V3_6</b>	Rotronic AG Bassersdorf, Switzerland
Document code	Unit
<b>HygroFlex HF5 Humidity Temperature Transmitters: User Guide</b>	<b>Instruction Manual</b>
	Document Type
Document title	Page <b>26</b> of 37

**Terminal block diagram (analog outputs only)**



Terminals	Description
AC N	Power supply neutral: 100 to 240 VAC
AC L	Power supply phase: 100 to 240 VAC
OUT1	Relative humidity or dew point
OUT2	Temperature output
GND	Ground (tied with other GND)
GND	Ground (tied with other GND)

**Terminal block diagram (analog outputs and digital option)**

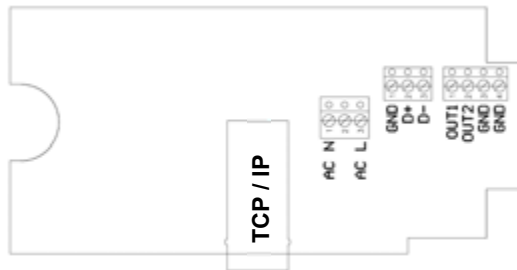

Terminals	Description
AC N	Power supply neutral: 100 to 240 VAC
AC L	Power supply phase: 100 to 240 VAC
GND	RS485 Ground
D+	RS485 Bi-directional TX+ / RX + (< 10,5 V, <10mA)
D-	RS485 Bi-directional TX- / RX - (< 10,5 V, <10mA)
OUT1	Relative humidity or dew point
OUT2	Temperature output
GND	Ground (tied with other GND)
GND	Ground (tied with other GND)

**Grounding (all models)**

We generally recommend grounding the (-) side of the power supply, especially if the electronics will be subjected to a low humidity environment (35 %RH or less)

<b>E-M-HF5-V3_6</b> Document code	Rotronic AG Bassersdorf, Switzerland Unit
<b>HygroFlex HF5 Humidity Temperature Transmitters: User Guide</b> Document title	<b>Instruction Manual</b> Document Type Page 27 of 37

## Operation

### 6.5 HF5 analog outputs

Use the HW4 software to configure the analog outputs of the HF5 as desired, complete the mechanical and electrical installation, connect the probe and simply power up the HF5.

### 6.6 HF5 digital outputs

The digital outputs of the HF5 use the standard RO-ASCII protocol and do not offer any other option. Users who wish to read the measurement data without the HW4 software should consult ROTRONIC.

The different types of digital interface available with the HF5 are best used with a PC with the HW4 software installed (version 3.0.0 or higher). In principle, users should be able to use communication software other than HW4 to read measurement data from the HF5. In this case, communication is limited to the **RDD** (data request) and **REN** (RS-485 address change) commands described separately in document E-M-AC3000-CP.

**IMPORTANT:** Depending on the type of digital interface, either the PC or the HF5 must be configured by the user as indicated below.

#### a) USB connection

Prior to connecting the HF5 to a USB port you must install the **ROTRONIC USB driver** on the PC (available from the HW4 CD or from [www.rotronic-humidity.com](http://www.rotronic-humidity.com)). For instructions see the HW4 manual **E-M-HW4v3-Main** (§ 7.3)

#### b) Ethernet (TCP/IP) connection

Prior to connecting the HF5 to an active Ethernet network you must configure the TCP/IP settings of the HF5 using either the HW4 software (version 2.1.0 or higher) or the TCP/IP configuration tool available from [www.rotronic-humidity.com](http://www.rotronic-humidity.com). For instructions see the HW4 manual **E-M-HW4v3-Main** (§ 7.4) and technical note **IN-E-TCPIP-Conf**

**WARNING:** Connecting a device to an active Ethernet network can disrupt communications on the network. Before connecting the HF5, make sure that it is properly configured for your network

#### c) RS-485 serial interface (multi-drop)

Instructions for using the HF5 with a RS-485 network are provided in the following manuals: **E-M-HW4v3-Main** (§ 7.5), **E-M-HW4v3-F2-005** and **E-DV04-RS485.01**.

#### Notes:

- Instruments connected to the same RS-485 network must use the same baud rate and each instrument must be given a unique RS-485 address (the address requirement applies to the HF5 but not to its probe)
- **RS-485 Compatibility:** The communications protocol used by the HF5 is the RO-ASCII protocol. This protocol is not compatible with the protocol used by the previous generation of ROTRONIC products. Do not connect legacy products and the HF5 to the same RS-485 multi-drop network.

The specifications of the RS-485 interface are as follows:

Baud rate : 19200  
Parity : none  
Data bits : 8  
Stop bits : 1

<b>E-M-HF5-V3_6</b> Document code	Rotronic AG Bassersdorf, Switzerland Unit
<b>HygroFlex HF5 Humidity Temperature Transmitters: User Guide</b> Document title	<b>Instruction Manual</b> Document Type Page <b>28</b> of 37

## 6.7 Display and keypad option



Except for the HF52 (2-wire circuit type), the LC display of the HF5 has a backlight.

The upper line corresponds to relative humidity the bottom line corresponds to temperature. If enabled the third line corresponds to the calculated Parameter.

The display can be configured to show a trend indicator on each line:

- ▲ : increasing value
- ▼ : decreasing value

In the event of an alarm the display shows the symbol [ ! ] to the right of the value.

For instructions about configuring the display, see the following HW4 manual: **E-M-HW4v3-F2-005**.

## 6.8 Internal menu (optional keypad and display)

Note: Unauthorized access to the menu can be prevented by disabling the “display menu” setting (use the HW4 software > Device Manager > Display)

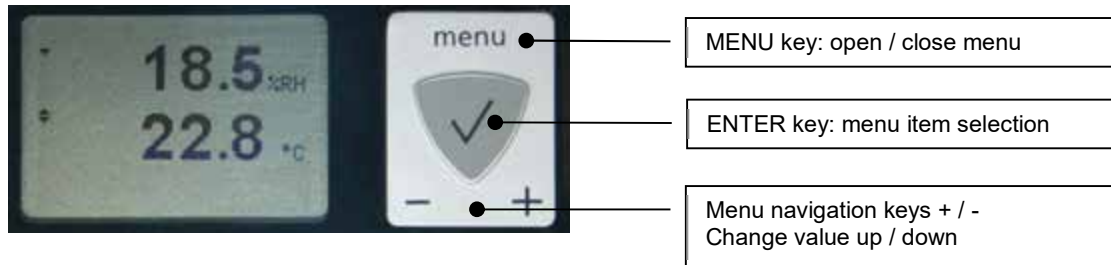

**Model HF52 (2-wire circuit type):**

Main Menu	Menu Items	Selections / Information	Notes
<b>Device Settings</b>			
	<b>Units</b>	Metric / English	
	<b>Contrast</b>		LC display contrast adjustment
	<b>Trend</b>	On / Off	Trend indication on the display
<b>Device Information</b>			
	<b>Version</b>	Firmware version	
	<b>Serial Nbr</b>	Serial number	
	<b>Address</b>	RS-485 address	
	<b>Type</b>	Device type	
	<b>Name</b>	Device name	User defined
<b>Probe Information</b>			
	<b>Version</b>	Firmware version	
	<b>Serial Nbr</b>	Serial number	
	<b>Address</b>	RS-485 address	

<b>E-M-HF5-V3_6</b> Document code	Rotronic AG Bassersdorf, Switzerland Unit
<b>HygroFlex HF5 Humidity Temperature Transmitters: User Guide</b> Document title	<b>Instruction Manual</b> Document Type Page 29 of 37

Main Menu	Menu Items	Selections / Information	Notes
	Name	Device name	User defined

Other HF5 models:

Main Menu	Menu Items	Selections / Information	Notes
<b>Device Settings</b>			
	Units	Metric / English	
	Back Light	Key Press / On / Off	Display backlight mode
	Contrast		LC display contrast adjustment
	Trend	On / Off	Trend indication on the display
<b>Device Information</b>			
	Version	Firmware version	
	Serial Nbr	Serial number	
	Address	RS-485 address	
	Type	Device type	
	Name	Device name	User defined
<b>Probe Information</b>			
	Version	Firmware version	
	Serial Nbr	Serial number	
	Address	RS-485 address	
	Name	Device name	User defined
	SensorTest	Humidity sensor status	Off / Good / SQ-Tuned / Bad
	Record	On / Off	Data recording by the probe (max. 2000 values)
<b>Humidity Adjust</b>			
	RefValue	Humidity reference value	± 0.1 %RH steps
	Acquired		Number of cal. points in probe memory
	<Acquire>		Save cal. point to probe memory
	<Delete>		Erases all calibration points
	<Adjust>		Effect depends on number of calibration points
<b>Temperature Adjust</b>			
	RefValue	Temperature reference value	± 0.1 °C steps
	<Adjust>		1-point adjustment only (offset)

- **Record:** both the recording mode (start / stop and the log interval cannot be changed from the menu and are as configured with the ROTRONIC HW4 software
- **SensorTest:** Off means that the humidity sensor has not been tested due to the configuration settings of the test. For a description of the automatic humidity sensor test and drift compensation (SQ-tuning) see documents **E-T-AC3000-DF-V1** and **E-M-HW4v3-F2-005**

<b>E-M-HF5-V3_6</b> Document code	Rotronic AG Bassersdorf, Switzerland Unit
<b>HygroFlex HF5 Humidity Temperature Transmitters: User Guide</b> Document title	<b>Instruction Manual</b> Document Type
	Page <b>30</b> of 37

## 6.9 Displayed parameters (optional keypad and display)

When the menu is not active, press the ENTER key to change which parameters are shown on the display:

- Relative humidity and temperature
- Relative humidity , temperature and calculated parameter (when the calculated parameter is enabled)

## 7 Maintenance

### 7.1 Service cable

#### IMPORTANT:

- Use service cable AC3009 with all 2-wire, loop powered transmitters. This cable powers up the transmitter via the service connector. Do not use any other method for powering the transmitter when using this cable AC3009 as this will create a ground loop and damage the transmitter. For the same reasons do not use cable AC3006 with a 2-wire, loop powered transmitter. Only with the new HF Firmware with SN (2xxxxxx) is this no longer required to use galvanically isolated computer or laptop.
- Use service cable AC3006 with all 3-wire transmitters as well as with digital models. This cable does not provide power to the transmitter and the transmitter should be powered separately when using this cable
- Both cables AC3006 and AC3009 convert UART (service connector) to USB and are used to connect the transmitter to a USB port of a PC running the ROTRONIC HW4 software. Prior to using any of these cables, the ROTRONIC USB driver must be installed on the PC. Both the driver and the installation instructions (document **E-M-HW4v3-Main**) are located on the HW4 CD.

### 7.2 Location of the service connector (mini USB type)

**WARNING:** the service connector is a UART interface with a mini-USB connector type. Do not connect the service connector directly to the USB port of a PC or hub.

The service connector can be accessed without opening the enclosure after removing the small red sealing cover.

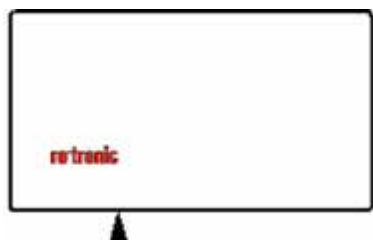

**Horizontal mount:** the service connector is located at the bottom of the enclosure (black arrow)

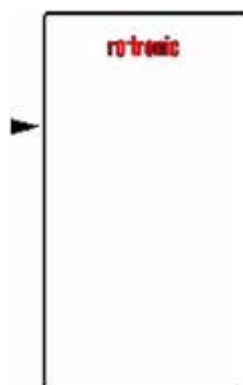

**Vertical mount:** the service connector is located either on the left side or on the right side of the enclosure.

<b>E-M-HF5-V3_6</b> Document code	Rotronic AG Bassersdorf, Switzerland Unit
<b>HygroFlex HF5 Humidity Temperature Transmitters: User Guide</b> Document title	<b>Instruction Manual</b> Document Type
	Page <b>31</b> of 37

### 7.3 Periodic calibration check of the probe

Both the Pt 100 RTD temperature sensor used in the probe and associated electronics are very stable and should not require any calibration after the initial factory adjustment.

Long term stability of the ROTRONIC Hygromer humidity sensor is typically better than 1 %RH per year. For maximum accuracy, calibration of the probe should be verified every 6 to 12 months. Applications where the probe is exposed to significant pollution may require more frequent verifications.

**Note:** the HygroClip 2 probe cannot be adjusted when connected to model HF52 (2-wire circuit type)

#### a) Procedure for adjusting the probe using the optional keypad (except model HF52)

##### *Temperature adjustment*

The keypad of the HF5 allows only a 1-point adjustment of temperature. The effect of a 1-point temperature adjustment is to add the same offset to all measured values.

- When temperature is stable, press the MENU key to show the internal menu on the display
- Use the (-) key to select Temperature Adjust and press the ENTER key
- Make sure that the text line beginning with RefValue is highlighted and press the ENTER key
- Use the (+) or (-) key to change the reference value to match the temperature reference
- Use the (-) key to highlight the Adjust text line and press the ENTER key
- The HF5 confirms the adjustment with the message "Adjust OK"
- Press the MENU key twice to exit the menu and return the HF5 to normal operation

##### **Notes:**

- Any temperature adjustment should be done prior to adjusting humidity.
- The calibration point is automatically deleted from the probe memory after an adjustment
- Because the HF5 has no real time clock, the date of the adjustment is not written to the probe. If retaining the adjustment date is important, use the HW4 software to adjust the probe.

##### *Humidity adjustment*

The keypad of the HF5 allows a multi-point adjustment of humidity. The effect of a humidity adjustment depends on the number of calibration points present in the probe memory prior to the adjustment:

- one calibration point: offset added to all measured values
- two calibration points: offset and slope
- three or more calibration points: offset, slope, linearity

For maximum accuracy use at least 3 to 4 calibration points distributed equally across the measurement range of interest. The calibration points (maximum 100) can be acquired in any order but we recommend going from low humidity values to high humidity values.

- When humidity is stable, press the MENU key to show the internal menu on the display
- Use the (-) key to select Humidity Adjust and press the ENTER key
- Make sure that the text line beginning with RefValue is highlighted and press the ENTER key
- Use the (+) or (-) key to change the reference value to match the reference humidity
- Use the (-) key to highlight the Acquire text line and press the ENTER key
- Note that the "Acquired" counter is incremented by 1 (number of calibration points in the probe memory)
- When all calibration points have been acquired, use the (-) key to highlight the Adjust text line and press the ENTER key. **Do not adjust the probe before having acquired all calibration points.**
- The HF5 confirms the adjustment with the message "Adjust OK"
- Press the MENU key twice to exit the menu and return the HF5 to normal operation

<b>E-M-HF5-V3_6</b> Document code	Rotronic AG Bassersdorf, Switzerland Unit
<b>HygroFlex HF5 Humidity Temperature Transmitters: User Guide</b> Document title	<b>Instruction Manual</b> Document Type Page 32 of 37

#### Notes:

- All calibration points are automatically deleted from the probe memory after an adjustment
- Instructions for using the ROTRONIC calibration devices and humidity standards are provided in document **E-M-CalBasics**
- Because the HF5 has no real time clock, the date of the adjustment is not written to the probe. If retaining the adjustment date is important, use the HW4 software to adjust the probe.

#### b) Using the HW4 software to adjust the probe connected to a HF5 (except model HF52):

- Use the appropriate model of service cable (see Maintenance > Service Cable) to connect the service connector of the HF5 to a USB port of a PC with the HW4 software installed. Note that the ROTRONIC USB driver must be installed on the PC as explained in the HW4 manual **E-M-HW4v3-Main**. In the case of the HF55, a connection with the PC can be established via the USB (ROTRONIC USB driver) or Ethernet interface.
- Start HW4 on the PC and search for the HF5 (HW4 Main Menu Bar > Devices and Groups > Search for USB Masters).
- After finding the HF5 with HW4, expand the device tree to see the HF5 functions. Select Probe and Probe Adjustment.
- For further instructions see HW4 manual **E-M-HW4v3-A2-001**

## 7.4 Cleaning

### Device

The device can be cleaned with a wet cloth.

### Probe

See document **E-M-HC2 Probes-V1**

## 7.5 Validation of the output signals transmission

If so desired, transmission of the HF5 output signals can be validated by using the simulator function. The HW4 software is required to enable and configure this function. When this function is enabled the HF5 generates fixed digital and analog signals as specified by the user. For instructions see document **E-M-HW4v3-F2-005**

## 7.6 Fuse

The device includes a fuse. This fuse can only be exchanged by Rotronic.

# 8 Firmware updates

Firmware updates will be available on the ROTRONIC website for downloading. Firmware files are given a name that shows both to which device the file applies and the version number of the firmware. All firmware files have the extension HEX or ROF. Procedure for updating the firmware:

- Use the appropriate model of service cable (see Maintenance > Service Cable) to connect the service connector of the HF5 to a USB port of a PC with the ROTRONIC HW4 software installed. Note that the ROTRONIC USB driver must be installed on the PC as explained in the HW4 manual **E-M-HW4v3-Main**. In the case of the HF55, a connection with the PC can be established via the USB (ROTRONIC USB driver) or Ethernet interface.
- Copy the firmware update file from the ROTRONIC website to the PC.
- Start HW4 software on the PC and search for the HF5 (HW4 Main Menu Bar > Devices and Groups > Search for USB Masters).
- After finding the HF5, expand the device tree to see the HF5 functions. Select Device Manager. In the Device Manager menu bar select Tools > Firmware Update. For instructions see document **E-M-HW4v3-F2-005**



<b>E-M-HF5-V3_6</b> Document code	Rotronic AG Bassersdorf, Switzerland Unit
<b>HygroFlex HF5 Humidity Temperature Transmitters: User Guide</b> Document title	<b>Instruction Manual</b> Document Type Page <b>33</b> of 37

## 9 Technical data

### 9.1 Specifications

General	HF52	HF53 / HF54 / HF56	HF556 / HF557 / HF566
Device type	Humidity temperature transmitter with analog output signals	Humidity temperature transmitter with analog output signals and optional digital output	Humidity temperature transmitter with digital output
Circuit type	2-wire, loop powered	3-wire	
Mechanical configuration types	D and W		

Power supply and connections	HF52	HF53 / HF54 / HF56	HF556 / HF557 / HF566
Supply voltage (VDD)	10...28VDC V min = 10 V + (0.02 x Load*) *Load resistance in Ω.	HF53: 18...40 VDC or 12...28 VAC  HF54: 9 to 36 VDC or 7 to 24 VAC Galvanic isolation  HF56: 100 to 240 VAC 47 to 63 Hz Galvanic isolation	HF556: 5...40 VDC or 12...28 VAC  HF557: PoE  HF566: 100 to 240 VAC 47 to 63 Hz
Typical current consumption	2 x 20 mA	HF53 / HF54: 100 mA  HF56: < 50 mA at 100 VAC < 35 mA at 240 VAC	HF 556: with USB interface: 100 mA  HF556 / HF557 with Ethernet interface: 300 mA  HF566: < 50 mA at 100 VAC < 35 mA at 240 VAC
Electrical connections	Terminal blocks and 1 x M16 cable grip or ½" conduit adapter	HF53 / HF54: Terminal blocks and 1 x M16 cable grip or ½" conduit adapter  HF56: Terminal blocks and 2 x M16 cable grip	HF556: Connector (USB or Ethernet), terminal blocks (power supply and RS-485) and 1 x M16 cable grip or ½" conduit adapter  HF557: Ethernet Connector  HF566: Connector (Ethernet), terminal blocks (power supply and RS-485) and 2 x M16 cable grip or ½" conduit adapter
Polarity protection	Protective diode on V+ (except HF56, HF57 and HF58)		
Fuse	HF56 / HF566: 2A fuse, soldered to PCB		

<b>Humidity and temperature measurement</b>	
See document <b>E-M-HC2 Probes</b> > Specifications	

<b>E-M-HF5-V3_6</b> Document code	Rotronic AG Bassersdorf, Switzerland Unit
<b>HygroFlex HF5 Humidity Temperature Transmitters: User Guide</b> Document title	<b>Instruction Manual</b> Document Type Page <b>34</b> of 37

Calculated parameters	HF52	HF53 / HF54 / HF56	HF556 / HF557 / HF566
Psychrometric calculations	Dew point (Dp) above and below freezing Frost point (Fp) below freezing and dew point above freezing Wet bulb temperature (Tw) Enthalpy (H) Vapor concentration (Dv) Specific humidity (Q) Mixing ratio by weight (R) Vapor concentration at saturation (Dvs) Vapor partial pressure (E) Vapor saturation pressure (Ew)		

Start-up time and data refresh rate	HF52	HF53 / HF54 / HF56	HF556 / HF557 / HF566
Start-up time	60 s (typical)	3.s (typical)	3 s (typical)
Data refresh rate	20 s (typical)	1 s (typical)	1 s (typical)

Configurable analog outputs	HF52	HF53 / HF54 / HF56
Output 1	Can be made to correspond to any parameter	
Factory default parameter	Relative humidity or dew / frost point	
Factory default scale	As per ordering code	
Output 2	Can be made to correspond to any parameter	
Factory default parameter	Temperature	
Factory default scale	As per ordering code	
Output 1 and Output 2		
Signal type	4...20 mA	0...20 mA 4... 20 mA 0... 1 V 0... 5 V 0... 10 V (user configurable)
Accuracy of analog output	±30 µA	±20 µA ±2 mV (0-1V) ±5 mV (0-10V)
User configurable scaling limits	-999.99 ... +9999.99 engineering units	
Short circuit tolerant	Yes	
Maximum external load	500 Ω	500 Ω (current output)
Minimum external load	0 Ω	1000 Ω (voltage output) 0 Ω (current output)

Digital interface	HF52	HF53 / HF54 / HF56	HF556 / HF557 / HF566
Interface type	N/A	HF53 / HF54: RS-485 or USB + RS-485 or Ethernet + RS-485  HF56: RS-485 + Ethernet	HF556/ HF566: RS-485 or RS-485 or Ethernet + RS-485  HF557: Ethernet

Service connector	HF52	HF53 / HF54 / HF56	HF556 / HF557 / HF566
Interface type	UART (Universal Asynchronous Receiver Transmitter)		
Maximum service cable length	5 m (16.4 ft)		

<b>E-M-HF5-V3_6</b> Document code	Rotronic AG Bassersdorf, Switzerland Unit
<b>HygroFlex HF5 Humidity Temperature Transmitters: User Guide</b> Document title	<b>Instruction Manual</b> Document Type Page 35 of 37

General specifications	HF52	HF53 / HF54 / HF56	HF556 / HF557 / HF566
Optional display	LC, 1 or 2 decimals resolution, no backlight, trend and alarm indication	LC, 1 or 2 decimals resolution, backlight, trend and alarm indication	
Housing material	ABS		
Housing protection grade	IP 65	IP 65* (except models with Ethernet, only IP20)	
	*Only IP65 when the red service plug is mounted		
Physical dimensions	See chapter "mechanical configuration and dimensions"		
Weight	250 g (8.8 oz)	Models with small enclosure: 250 g (8.8 oz) Models with large enclosure: 540 g (1 lb 3 oz) Models in aluminum enclosure: 750 g (26.5 oz)	
Impact stress	IK08 according to IEC 62262 (horizontal impact)		
Degree of pollution	2		
Overvoltage category	-		II

Conformity with standards	HF52	HF53 / HF54 / HF56	HF556 / HF557
CE / EMC immunity	EMC Directive 2014/30/EU: EN 61000-6-1: 2007 EN 61000-6-2: 2005 EN 61000-6-3: 2007 EN 61000-6-4: 2007 + A11: 2011 EN 50581: 2012 EN 61326-1: 2013	EMC Directive 2014/30/EU: HF53 / HF54: EN 61000-6-1: 2007 EN 61000-6-2: 2005 EN 61000-6-3: 2007 EN 61000-6-4: 2007 + A11: 2011 EN 50581: 2012 HF56: EN61326-1:2013	EMC Directive 2014/30/EU: EN 61000-6-1: 2007 EN 61000-6-2: 2005 EN 61000-6-3: 2007 EN 61000-6-4: 2007 + A11: 2011 EN 50581: 2012
Solder type	Lead free (RoHS directive)		
Fire protection class	Corresponds to UL94-HB		
FDA / GAMP directives	compatible		

Environmental limits	HF52	HF53 / HF54 / HF56	HF556 / HF557 / HF566
Storage and transit	-50...+70 °C / -20...+70 °C (models with display), 0... 100 %RH, non-condensing		
Operating limits at electronics	-40...+60 °C -10...+60 °C (models with display) 0...100 %RH, non-condensing	HF53 / HF54 : -40...+60 °C -10...+60 °C (models with display) HF56: -10...50 °C (models with/out display) 0...100 %RH, non-condensing	HF556 / HF557 -40...+60 °C -10...+60 °C (models with display) HF566: -10...50 °C (models with/out display) 0...100 %RH, non-condensing
Temperature limits at probe	Depends on probe model		
Maximum humidity at sensor	100 %RH up to 80 °C (176 °F) 75 %RH at 100 °C (212 °F) 45 %RH at 125 °C (260 °F) 15 %RH at 150 °C (302 °F)		
Maximum air velocity at probe	20 m/s (3,935 ft /min)		
Critical environments	Humidity sensor: as per DV04-14.0803.02 – Critical chemicals		
Maximal operating altitude	2000 metres above sea level		

<b>E-M-HF5-V3_6</b> Document code	Rotronic AG Bassersdorf, Switzerland Unit
<b>HygroFlex HF5 Humidity Temperature Transmitters: User Guide</b> Document title	<b>Instruction Manual</b> Document Type Page <b>36</b> of 37

## 9.2 Dew point accuracy

See document **E-M-HC2 Probes > Dew point accuracy**

## 10 Accessories

For accessories and parts such as the HW4 configuration software, service cables, calibration accessories and spare dust filters, please see document **E-M-HC2-accessories**

## 11 Supporting documents

Document File Name	Contents
<b>E-M-HC2 Probes-V1</b>	HygroClip 2 (HC2) Humidity Temperature Probes, User Guide
<b>E-M-HC2-accessories</b>	Accessories and parts for probes, indicators and transmitters
<b>E-T-AC3000-DF-V1</b>	AirChip 3000 Description and Main Functions
<b>E-M-HW4v3-DIR</b>	List of the HW4 manuals
<b>E-M-HW4v3-Main</b>	HW4 software version 3: General instructions and functions common to all devices
<b>E-M-HW4v3-F2-005</b>	HW4 software version 3: Device Manager – HF5 transmitter
<b>E-M-HW4v3-F2-001</b>	HW4 software version 3: Device Manager – HC2 probe series
<b>E-M-HW4v3-A2-001</b>	HW4 software version 3: Probe Adjustment function AirChip 3000 devices
<b>E-M-HW4v3-DR-001</b>	HW4 software version 3: Data Recording Function AirChip 3000 Devices
<b>E-M-AC3000-CP</b>	AirChip 3000 Communication Protocol Options
<b>E-DV04-RS485.01</b>	RS485 Network Installation and Start-up Guidelines
<b>E-M-TCPIP-Conf</b>	Configuration procedures for ROTRONIC devices with Ethernet (TCP/IP) interface
<b>E-M-CalBasics</b>	Temperature and humidity calibration basics Instructions for using the ROTRONIC humidity standards
<b>E-T-HumiDefs</b>	Humidity Definitions

**Note:** All document file names have an extension corresponding to the document release number. This extension is not shown in the above table.

<b>E-M-HF5-V3_6</b> Document code	Rotronic AG Bassersdorf, Switzerland Unit
<b>HygroFlex HF5 Humidity Temperature Transmitters: User Guide</b> Document title	<b>Instruction Manual</b> Document Type Page 37 of 37

## 12 Document releases

Doc. Release	Date	Notes
V2_10	Dec. 14, 2010	Original release
V2_11	Oct. 28, 2011	Updated this document regarding the model of service cable to be used with 2-wire and 3-wire models.
V2_12	Mar. 27, 2013	Changed the HF52 operating limits at electronics
V3_0	July, 2014	Changed the HF52 operation limits to -40...60 °C (new hardware version). Added Electrical Safety Warnings. Added HF5xx-S (Alu enclosure) Model
V3_1	May 2015	Several points according to DIN EN 61010.1:2010
V3_2	July 24, 2015	Accuracy of analog outputs added
V3_3	Sep 08, 2015	Power Supply change 15...40 VDC to 18...40 VDC Changes for HF56x according to actual standards.
V3_4	Sept 18, 2015	Changes for HF56x according to actual standards.
V3_5	Nov. 11.2015	AC3006 with 2-wires transmitters. Galvanically isolated computer is no longer required with the new Firmware (2xxxx)
V3_6	June 2016	Updated the weight specification with the aluminum enclosure. Updatet with the HF56 High voltage specifications and new PCB design