



CTX200 RJ45/Coax Cable Tester



USER MANUAL

Introduction

Congratulations on your purchase the CTX200 RJ45/Coax Cable Tester.
The system consists of a Main Tester and a Remote Terminator and
Performs the following tests: Continuity, Open & Short Circuits, Wire
Crossed (Reverse and Split) Tests CAT3, 5, 5e, 6, 6A, & 7 Ethernet Cables
to TIA568 Specs • Tests COAX Cables • Locates Cables*

WARNING!!!
DO NOT USE ON LIVE CIRCUITS!!
****NOTE: <5V/20mA rating****

Features

- Tests and tones both RJ45-CAT5/6 and coax cables.
- Ruggedized for field use. Small and easy to carry.
- PASS/FAIL results appear in one second.
- Each pair's status is highlighted.
- Complete TIA568 test performed. Continuity, opens / shorts, reversals and split pairs.
- Auto-off (12 seconds) to conserve battery life.
- Low battery indicator.
- (1) 9V Battery and Pouch included.

Quick Start: Cable Testing

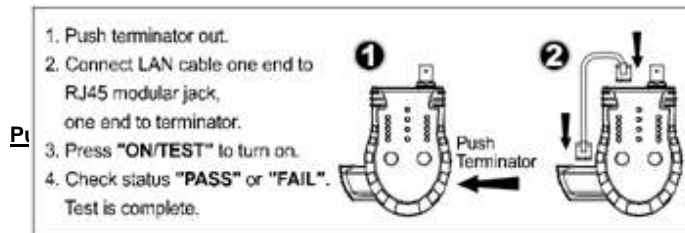

Ethernet cables have 4 pairs of wires ("twisted pairs"). It is important that the pairs correctly go to connector pins 1,2 ; 3,6 ; 4,5 ; and 7,8. The Pocket CAT tests for the proper pairing and if there is an error it will report it to you ("split pairs")

Connecting cables to the Tester

Installed cables: Connect the Main unit to the wall jack, then connect the Remote to the patch panel or far-end wall jack.

Patch cables: Attach the Main unit and Remote directly to the cable ends.

Power ON and Test

Press the ON button. Press again to begin test. When the PASS/FAIL LEDs light, press the FAULT CHECK button to isolate any problems to an individual pair.

Coax Testing Coax is displayed using the 4/5 LEDs. The coax remote is in the pouch.

• To press "TEST" for quickly test or press "PAIR" for individual test are listed below:

Indicator light reference ● ON ○ OFF ☀ FLASHING.

EIA/TIA-568A

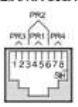

4 PAIR TEST
 PASS = YELLOW x 4 ● (ON)
 FAIL = RED ● (ON)
 Yellow ○ (OFF) or
 ☀ (FLASHING)

● 1 & 2	○ OPEN
● 3 & 6	○ SHORT
● 4 & 5 (20MA)	○ CROSS
● 7 & 8	○ SPLIT
○ SHIELD	○ []

EIA/TIA-568B (AT&T-258A)



4 PAIR TEST
 PASS = YELLOW x 4 ● (ON)
 FAIL = RED ● (ON)
 Yellow ○ (OFF) or
 ☀ (FLASHING)

● 1 & 2	○ OPEN
● 3 & 6	○ SHORT
● 4 & 5 (20MA)	○ CROSS
● 7 & 8	○ SPLIT
○ SHIELD	○ []

EIA/TIA-568A

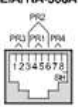

4 PAIR + SHIELD TEST
 PASS = YELLOW x 5 ● (ON)
 FAIL = RED ● (ON)
 Yellow ○ (OFF) or
 ☀ (FLASHING)

● 1 & 2	○ OPEN
● 3 & 6	○ SHORT
● 4 & 5 (20MA)	○ CROSS
● 7 & 8	○ SPLIT
● SHIELD	○ []

Quick Start Purpose

10BASE-T

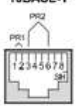

2 PAIR TEST (1-2 AND 3-6)
 PASS = YELLOW x 2 ● (ON)
 FAIL = RED ● (ON)
 Yellow ○ (OFF) or
 ☀ (FLASHING)

● 1 & 2	○ OPEN
● 3 & 6	○ SHORT
○ 4 & 5 (20MA)	○ CROSS
○ 7 & 8	○ SPLIT
○ SHIELD	○ []

Tone is used to locate a cable's far end. A tone is placed on the cable's "near end" by the CTX200 Main unit. The probe locates the tone at the far end of the cable. NOTE: Requires

Connecting cables to the Tester

Plug the cable into the tester's Main unit.

Power ON and Tone:

Press the ON button. Hold the TONE button for 7 secs to turn ON the tone. Press the TONE button repeatedly to select the pair you wish to tone. The tone is loudest when you select the entire cable (including the shield).

Connecting the Cable Tester

Testing patch cables

Slide Remote Connector out from base of Pocket CAT, then connect one end of the cable to the Remote Connector, and the other end to the Pocket CAT.

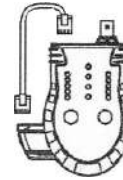

Testing installed cables

Slide Remote Connector out from base of Pocket CAT, then connect the far end of the cable to the Remote Connector, and the other end to the Pocket CAT. NOTE: The Remote Connector for COAX testing is located in the pouch..

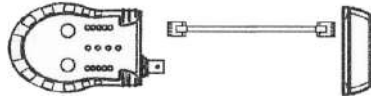

Faceplate



OPEN: A wire is disconnected.

SHORT: A wire makes contact with another wire.

CROSS (REVERSAL): a twisted pair gets flipped on one side of the cable

Pass/Fail Indicator



Pair/Shield Tested
(Coax uses 4/5)



Press to test all pairs automatically.



Press to test pairs individually. Hold 7 second for Tone and Press again to select pair. Remote Connector: Push or Slide to Remove.

Testing RJ45 and Coax Cables

Power ON and TEST: Press the ON button. Press again to commence the test. The bright, blue PASS LED indicates the cable has passed. If the FAIL LED lights, press the FAULT CHECK button to isolate problems to an individual pair. See back for more examples.

Power ON and TEST: Press the ON button. Press again to commence the test. The bright, blue PASS LED indicates the cable has passed. If the FAIL LED lights, press the FAULT CHECK button to isolate problems to an individual pair. See back for more examples.

EXAMPLE: CABLE PASSED
TEST. ALL 4 PAIRS AND
SHIELD ARE WIRED.



Coax cable: LEDs 4/5 are used for testing.



If FAIL, press FAULT CHECK to isolate problem to an individual pair(s).

Testing Examples: Coax

The Pocket CAT uses LED 4&5 to display the status of a coax cable test.. Connect the near end of the cable to the BNC connector. Connect the far end to the coax terminator (pouch).

Good Cable:

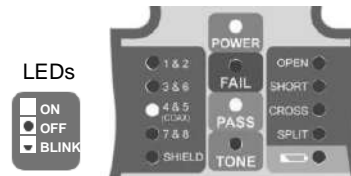

Short in Cable:

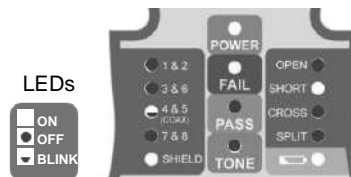

Testing Examples: Ethernet

Ethernet cables have 4 pairs of wires ("twisted pairs"). It is important that the pairs correctly go to connector pins 1,2; 3,6; 4,5; and 7,8. The tester tests for the proper pairing and if there is an error it will report it to you. The following examples are based on EIA/TIA 568B (the most popular ethernet wiring standard).

Good Cable:

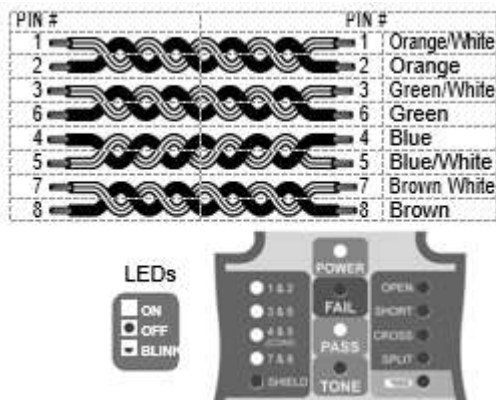

Open on Pair 1-2:

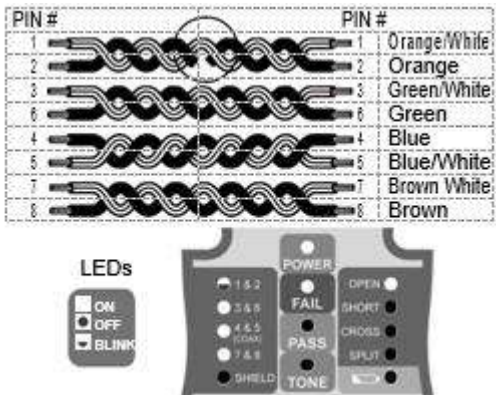

Split Pairs 1-2 & 3-6:

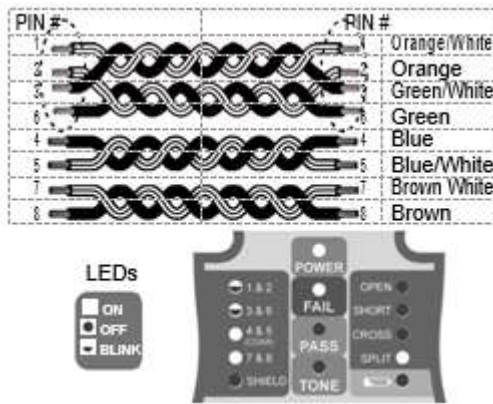

Short on Pair 3-6:

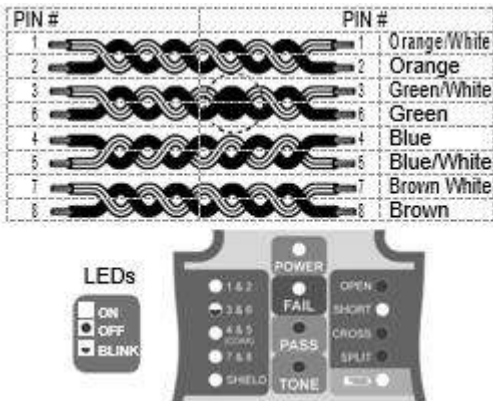

Crossed Pairs 4-5 & 7-8:

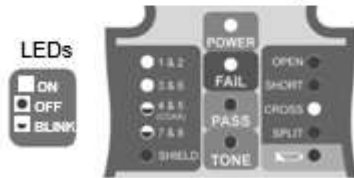
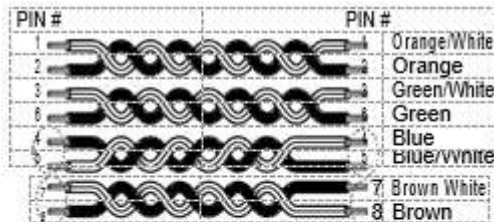

Copyright © 2019 Triplet

LIMITED WARRANTY
 The manufacturer warrants to the original consumer that this product is in good working order for a period of one year from the date of manufacture or the date of purchase. During this period, the product will be repaired or replaced without charge for either parts or labor. Repair or replacement as provided under this warranty is the exclusive remedy of the purchaser.