

BK PRECISION

Model 878B, 879B

Dual Display LCR METER

INSTRUCTION MANUAL



Safety Summary

The following safety precautions apply to both operating and maintenance personnel and must be observed during all phases of operation, service, and repair of this instrument.

DO NOT OPERATE IN AN EXPLOSIVE ATMOSPHERE

Do not operate the instrument in the presence of flammable gases or fumes. Operation of any electrical instrument in such an environment constitutes a definite safety hazard.

KEEP AWAY FROM LIVE CIRCUITS

Instrument covers must not be removed by operating personnel. Component replacement and internal adjustments must be made by qualified maintenance personnel.

DO NOT SUBSTITUTE PARTS OR MODIFY THE INSTRUMENT

Do not install substitute parts or perform any unauthorized modifications to this instrument. Return the instrument to B&K Precision for

service and repair to ensure that safety features are maintained.

WARNINGS AND CAUTIONS

WARNING and **CAUTION** statements, such as the following examples, denote a hazard and appear throughout this manual. Follow all instructions contained in these statements.

A **WARNING** statement calls attention to an operating procedure, practice, or condition, which, if not followed correctly, could result in injury or death to personnel.

A **CAUTION** statement calls attention to an operating procedure, practice, or condition, which, if not followed correctly, could result in damage to or destruction of part or all of the product.

Safety Guidelines

To ensure that you use this device safely, follow the safety guidelines listed below:

- This meter is for indoor use, altitude up to 2,000 m.
- The warnings and precautions should be read and well understood before the instrument is used.
- When measuring in-circuit components, first de-energize the circuits before connecting to the test leads.
- Discharge capacitor before testing.
- The meter is safety-certified in compliance with EN61010 (IEC 1010-1) Installation Category II (CAT. II) 50 V, Pollution Degree 2 environment.
- Use the meter only as specified in this manual. Otherwise, the protection provided by the meter may be impaired.
- The power for the meter is supplied with a single standard 9V battery. But also a line operation is possible using a 12V AC to DC adaptor. If a power adaptor is selected, please be sure it fulfills the safety requirements of a relevant IEC standard.

Safety Symbols



This symbol is a warning and indicates that the user should refer to the operating instructions located in the manual.



DC Current



Indicates inside pin is positive (+), outside is negative (-)

Compliance Statements

**Disposal of Old Electrical & Electronic Equipment
(Applicable in the European
Union and other European countries with separate
collection systems)**

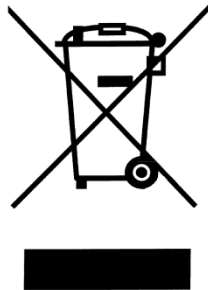

This product is subject to Directive 2002/96/EC of the European Parliament and the Council of the European Union on waste electrical and electronic equipment (WEEE) , and in jurisdictions adopting that Directive, is marked as being put on the market after August 13, 2005, and should not be disposed of as unsorted municipal waste. Please utilize your local WEEE collection facilities in the disposition of this product and otherwise observe all applicable requirements.

Environmental Conditions

Operating Environment	0 °C to 40 °C
Storage Humidity	0 – 80% R.H.
Storage Environment	-20 °C to +50 °C
Pollution degree	Pollution degree 2

TABLE OF CONTENTS

Safety Summary	1
Safety Guidelines	2
Compliance Statements	4
INTRODUCTION	10
PACKAGE CONTENTS	11
FRONT PANEL OVERVIEW	12
Front Panel Display Descriptions	13
Front Panel Buttons	15
LCD DISPLAY OVERVIEW	17
LCD Display Descriptions	17
Special Display Indicators.....	19
POWERING INSTRUMENT	20
Installing Battery	20
Connecting External Power Source	22
Low Battery Indication	24
Backlit Display (model 879B only)	25
OPERATION INSTRUCTIONS	27
Data Hold.....	27
Static Recording	27

L/C/R/Z Select Mode	30
D/Q/θ/ESR Select Mode	31
Test Frequency	31
Relative Mode	50
Tolerance	52
Utility Menu	56
Parallel and Series Measurement Mode	67
Calibration	85
USB	90
Automatic Fuse Detection	91
QUICK START GUIDE	93
CAUTION	93
Inductance Measurement	94
Capacitance Measurement	96
Resistance Measurement	98
Impedance Measurement (Model 879B only)	99
REMOTE COMMUNICATION	101
Connecting Instrument to PC	101
USB (Virtual COM) Configuration	103
USB Operation	103
Command Protocols	105

SUPPLEMENTAL INFORMATION 118
 Selecting Test Frequency 118
 Selecting Series or Parallel Mode 120
 Accuracy Discrepancies 121
 Guard Terminal 123
SPECIFICATIONS 125
 General Specifications 126
 Accuracy Specifications 127
MAINTENANCE 133
 Service 133
 Cleaning 133
SERVICE INFORMATION 135
LIMITED WARRANTY 136

INTRODUCTION

B&K Precision's 878B and 879B 40,000-count L/C/R hand-held meter is designed ideally for measuring inductance, capacitance and resistance components. Simple to operate, the instrument not only takes absolute parallel mode measurements, but also series mode measurement. The meter provides direct and accurate measurements with selectable testing frequencies.

Front panel push buttons maximize the convenience of function and feature selection such as data hold, maximum, minimum and average record mode, relative mode, tolerance sorting mode, frequency and L/C/R selection.

The test data can be transferred to PC through a Mini USB connection, great for applications that require data logging

A tilt stand provides position flexibility for viewing and operating the meter. The over-molding rubber case protects the meter for better durability. Additionally, top rubber visor molding above the screen is designed to prevent scratches on the display when meter is positioned upside down.

A single 9V battery or the included DC 12V power adaptor (model 879B only) can be used to power the meter. This gives user flexibility for portable or bench-top use.

PACKAGE CONTENTS

Each 878B and 879B LCR meters are shipped with the following contents.

- 878B or 879B LCR meter
- Instruction Manual
- Mini USB Interface Cable
- Red & Black Banana to Alligator Test Leads
- 9V Battery
- *AC Adapter (model 879B only)

**This can be purchased as an optional accessory for model 878B.*

Please locate them from the original packaging to ensure nothing is missing. If in the case that an item is missing, please contact B&K Precision immediately.

FRONT PANEL OVERVIEW

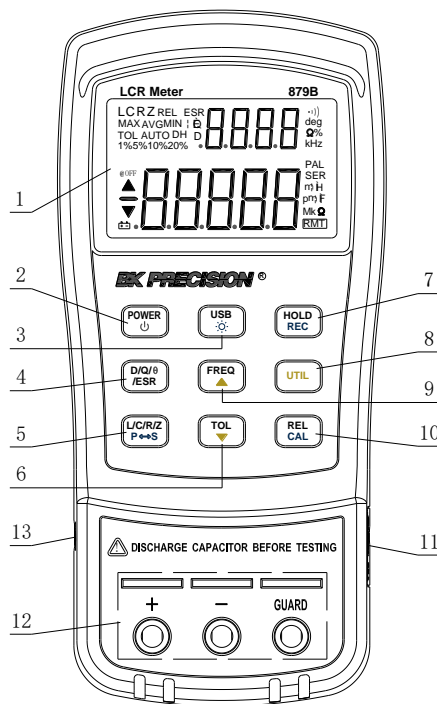

Figure 1 - Front Panel Display (model 879B shown)

Front Panel Display Descriptions

1. LCD Display
2. Power ON/OFF Button
3. USB Communication / *Back light button
4. Secondary Display mode (for dissipation factor(D), quality factor (Q), *phase angle (θ), *equivalent series resistance (ESR) measurement) selection button
5. Primary Display mode (for inductance, capacitance, resistance, and *impedance measurements) / Parallel or Series measurement method selection button
6. Tolerance mode / Utility down arrow selection button
7. Hold Display mode / Record mode selection button
8. Utility menu button
9. Test Frequency / Utility up arrow selection button
10. Relative mode / Calibration mode selection button
11. 12V DC adapter input (use with an external power adapter (rated 12VDC, 150mA, 4mm power plug))

Note: Use with included power adapter only. Use with improper power adapters may damage instrument.

WARNING: Before connecting an external power adapter, please check the battery compartment in the rear side of the unit. If a battery is installed, be sure that the polarity matches the (+) and (-) labels as indicated inside the battery compartment. If it is not installed correctly, please remove the battery and install it with correct matching polarity as indicated in the compartment. See “Installing Battery” section for details. DO NOT, at any time, connect an external power adapter when a battery is installed incorrectly. Doing so will damage the instrument and void its warranty.



Input sockets (banana jack inputs) and terminals for positive, negative, and guard (see “Guard Terminal” in “

12. SUPPLEMENTAL INFORMATION” section for details)
13. Standard mini USB port (for remote controllability)

**For model 879B only. Not included on model 878B.*

Front Panel Buttons

All front panel buttons have specific colored labels on them. They are all marked in white, blue, or yellow color. Each color has a specific representation, as described below:

- White** – With the exception of the  button, all white colored labels represent the primary function of that button; meaning that function will be set or configured upon pressing it.
- Blue** – Some of the buttons have a blue label underneath a white label. This means the function indicated by the blue label will be set or configured if that button is pressed and hold down for **2 seconds**.
- Yellow** – There are total of 3 buttons with yellow labels. They are 



. These functions are exclusively for use when entering **UTIL** menu only. See "Utility Menu" section for details.

LCD DISPLAY OVERVIEW

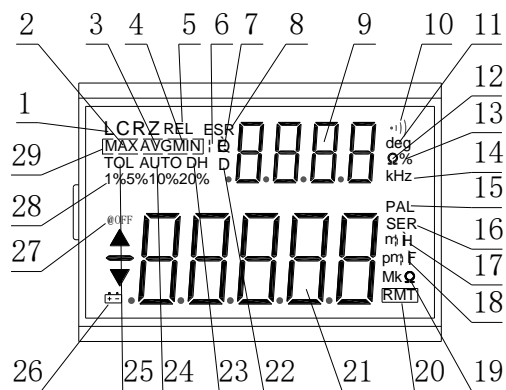









Figure 2 - LCD Indicator Display

LCD Display Descriptions

1. LCRZ – Primary display function indicator (*Z display)
2. MAX – Maximum reading indicator
3. AVG – Average reading indicator
4. MIN – Minimum reading indicator
5. REL – Relative mode indicator

6. Θ – *Phase angle indicator for secondary display
7. Q – Quality factor indicator
8. ESR – *Equivalent series resistance indicator
9.  – Secondary display
10.  – Beeper tone indicator for tolerance mode
11. deg – *Phase angle degree indicator
12. Ω – *ESR(ohm) units indicator
13. % - Tolerance percentage indicator
14. kHz – Frequency units indicator
15. PAL – Parallel mode indicator
16. SER – Series mode indicator
17.  – Inductance units (Henry) indicator
18.  – Capacitance units (Farad) indicator
19. M Ω – Resistance units (Ohm) indicator
20.  – Remote mode indicator
21.  – Primary display
22. D – Dissipation factor indicator
23. DH – Data hold indicator
24. AUTO – Auto-ranging indicator
25. TOL – Tolerance mode indicator
26.  – Low battery indicator
27. @OFF – Auto power-off indicator
28. 1%5%10%20% - Tolerance sorting percentage indicator

29. MAX AVG MIN – Recording mode indicators

**For model 879B only. Not included on model 878B.*

Special Display Indicators

SHRT	Indicates short connectors
OPEN	Indicates open connectors
Err	Error indication
CAL	Indicates calibration mode
FUSE	Indicates damaged or open fuse
EO1	AD converter error
EO2	AD converter error

POWERING INSTRUMENT

Before beginning to operate the instrument, a power source is necessary for it to turn on. There are two methods to power the instrument: Battery and external source.

Installing Battery

The 878B and 879B LCR meters can use a battery to provide power to the instrument so that it can be portable.

The meters use a standard 9V size battery (or NEDA 1604, JIS006P, IEC6F22 carbon-zinc or alkaline battery).

To install the battery:

1. Place the meter upside down. Open up the back-flip stand, and locate the screw that tightens the battery compartment cover as indicated in Figure 3. Use a screwdriver to unscrew and remove the cover.



Figure 3 - Back Cover

2. Insert 9V battery into compartment. Note the positive (+) and negative (-) terminals as indicated inside the battery compartment (See Figure 4). Be sure to insert the battery with matching polarity.

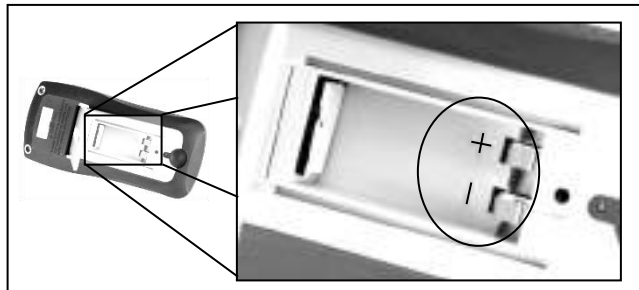



Figure 4 - Battery Compartment

3. Place the battery compartment cover piece by sliding it into the top slid first. Place screw at the bottom of the cover piece and tighten down with a screw driver.
4. Push and hold down the  button for 2 seconds to turn on the instrument.

Connecting External Power Source

The 878B and 879B can also be powered using an external AC adapter. The model 879B comes with this adapter included in the package, while it is optional for model 878B.

For external power, use AC adapter rated for output 12VDC, 150mA, with a standard 4mm connector only.

WARNING: Use of incorrect adapters may damage the instrument. Please use B&K Precision's adapter only.

To connect the adapter, do the following:

1. If a battery is installed, please check the battery compartment again that the polarity of the battery matches the polarity as indicated by the labels inside the compartment. If it is not, please remove and insert the battery with matching polarity. If a battery is not installed, continue to the next step.

WARNING: DO NOT, at any time, connect an external power adapter when a battery is installed incorrectly (reverse polarity or non-matching polarity to indicator of battery compartment). Doing so will damage the instrument and void its warranty.

2. Connect the AC adapter connector into the right side panel of the instrument. See Figure 5 below.

3. Now, connect the AC Adapter socket into an electrical outlet.
4. Push and hold down the  button for 2 seconds to turn on the instrument.

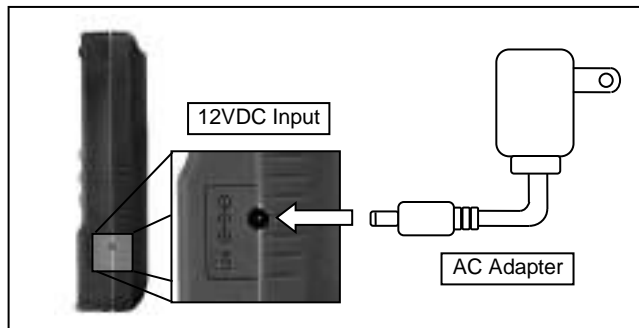



Figure 5 - Connecting AC Adapter to Meter

Note: The meter can be operated with a battery installed while an AC adapter is plugged in at the same time (As long as the battery is inserted properly with correct polarity). In this event, the meter will automatically switch to consume power from the AC adapter instead of the battery to preserve battery life.

Low Battery Indication

The LCR meter has a low battery indicator to notify the user when to replace battery. When the display

starts flashing the  indicator, the battery voltage is below normal working voltage. In this case, accuracy of the meter will also decrease. It is recommended that the battery be replaced as soon as possible before continuing operation. See “Installing Battery” for instructions.

Backlit Display (model 879B only)

Model 879B LCR meter has a backlit display that allows you to see the LCD display in dark conditions.

To turn **on** the back light, press and hold down  button for 2 seconds. Back light will turn on and brighten the LCD display.

To turn **off** the back light at any time, press and hold down  button for 2 seconds again. Back light will turn off and return to normal display.

When Using Battery Power

When the meter is powered using 9V battery, the back light display will turn on upon holding down the  button for 2 seconds. It will stay at maximum

brightness for 15 seconds. After another 15 seconds (30 seconds total from the time of turning on), the back light will automatically turn off to conserve battery power.

When Using External Power

When the meter is powered using an external AC adapter, the back light display will turn on upon

holding down the  button for 2 seconds. It will stay at maximum brightness continuously until the

user presses and holds down the  button for 2 seconds again.

Note: *If a battery is installed while using an AC adapter simultaneously, unplugging the AC adapter will automatically turn off the back light after it has been lit for 30 seconds.*

OPERATION INSTRUCTIONS

Data Hold

The data hold function allows the user to freeze the display when pressed, holding the measured value until data hold is turned off.

Turn On Data Hold

To use data hold, press the  button once. The “DH” indicator will display on the screen when data hold is active.

Turn Off Data Hold

To disable the data hold, press  again. The “DH” indicator will disappear on the screen, and meter will remain in normal operation mode.

Note: *Changing the primary function, secondary function, or test frequency will automatically turn off the data hold.*

Static Recording



This mode is used for recording maximum, minimum, and average values. It is often useful for testing the range of values in which a component is expected to fall within upon measurement.

Enable Static Recording

Press and hold down the  button for two seconds to enter the static recording mode. The display should indicate “**MAX AVG MIN**” simultaneously. This indicates the meter is in static recording mode and recording is performed immediately.

Using Static Recording

There are four different modes that can be selected in static recording. They are indicated by the descriptions below. These modes can be changed

with each  button press. Per each press of the  button, the modes will change and repeat in the following order:

Recording Mode → Maximum Mode → Minimum Mode → Average Mode

Recording Mode

This is the default mode when first enabling static recording. In this mode, the screen will display “**MAX AVG MIN**” indicator. At this point, the meter will start making recordings based on measured values from

the input sockets or terminals. As recording is performed, maximum, minimum, and average values will be stored after a brief moment. A beep tone will sound once a recording has been stored.

***Note:** Subsequent beep tones may occur in this mode if there are new values that are recorded. For example, if a new maximum is detected, it will beep once again to indicate that the new value has been stored. Any previously stored values will be overwritten with the new recorded values.*

Maximum Mode

In this mode, the “**MAX**” indicator will be shown on display. This indicates that the value in the primary display represents the recorded maximum value.

Minimum Mode

In this mode, the “**MIN**” indicator will be shown on display. This indicates that the value in the primary display represents the recorded minimum value.

Average Mode

In this mode, the “**AVG**” indicator will be shown on display. This indicates that the value in the primary display represents the recorded average value. This average value is obtained by taking the maximum and minimum recorded values and taking the average of the two values.



Disable Static Recording

To exit this mode, press and hold the  button for two seconds. The “**MAX AVG MIN**”, “**MAX**”, “**MIN**”, or “**AVG**” indicator will disappear on screen.

Note: *Changing the primary function, secondary function, or test frequency will automatically turn off static recording.*

L/C/R/Z Select Mode



The primary display of the LCR meter is used to indicate measured values under four different modes (*three modes for model 878B, which excludes Z (impedance) measurements*). These modes are: L (inductance), C (capacitance), R (resistance), and Z (impedance).

To change between these four primary modes of measurement, press the  (or  for model 878B) button. The modes will change and repeat upon each button press. On the screen, the indicators “**L**”, “**C**”, “**R**”, or “**Z**” (model 879B only) will be displayed to indicate which mode the meter is in.

D/Q/θ/ESR Select Mode

The secondary display of the LCR meter is used to indicate measured values for four various parameters (*two for model 878B, which excludes θ and ESR measurement mode*), which provide additional information of the component being tested and is supplementary to the primary mode measurements. These modes are: D (Dissipation factor), Q (Quality factor), θ (Phase angle), and ESR (Equivalent series resistance).

To change between these measurement parameters,

press the  (or  for model 878B) button. The parameters for measurement will change and repeat upon each button press. On the screen, the indicators “D”, “Q”, “ θ ” (*model 879B only*), or “ESR” (*model 879B only*) will be displayed to indicate which secondary mode the meter is in.

Test Frequency

The 879B and 878B LCR meters use an AC signal to test and measure components at the input sockets or terminals. With this measurement method, a test frequency must be selected. The test frequency can affect the accuracy of the results depending on what frequency is selected and what type and value of a component is being measured or tested.

For details on selecting the optimal test frequency for measurement, refer to the “

REMOTE COMMUNICATION

The meter has the capability to communicate with a PC over the mini USB interface. Upon installation of a USB driver, the PC can control the instrument over virtual COM (RS-232). The mini USB communication interface of the meter is designed in full duplex and has a 64-byte input and output buffer, making it reliable and efficient for data transmission.

Connecting Instrument to PC

Follow the below procedures for connection setup.

1. Download the USB drivers from
2. With the included mini USB cable, connect the mini USB end to the LCR meter and the other end to an available USB port on the PC (see Figure 14).
3. When Windows recognize the USB connection, do not follow the default Windows driver installation wizard. Simply run the setup file from the downloaded USB drivers and follow the prompt to install drivers.
4. When completed, the computer will recognize the instrument as a USB (virtual COM) device,

USB (Virtual COM) Configuration

The USB will be recognized as a virtual COM on the PC, thus serial port settings must be configured properly for remote communication to be successful. Below are the settings used by the 878B and 879B meters.



- Baudrate: **9600**
- Data bits: **8**
- Parity: **None**
- Stop bits: **1**
- Flow Control: **None**



USB Operation

There are two modes that describe the operation of the meter when it is setup for remote communication. They are remote mode and auto fetching mode.

Remote Mode

Upon connecting to the instrument, sending any commands listed in the “Command Protocols” section will automatically set the LCR meter into remote mode. In remote mode, the LCD display will show the RMT indicator. When this is shown, all front panel

buttons will be disabled, except for the  (or  for model 878B) button.



To exit remote mode and go back to local mode, press the  (or  for model 878B) button once. The **RMT** indicator will disappear on the LCD display. Pushing the same button once more will put the meter into auto fetching mode, which is described in the next section.

Auto Fetching Mode



When connected to a PC, the meter can be configured to auto-fetching mode. This means, the meter will continuously fetch data to the PC after every measurement cycle is completed. It fetches data from measured readings of primary display and secondary display, as well as tolerance compared results. This mode is useful when doing quick data logging using PC.

Enable/Disable Auto Fetching

To toggle between **enabling** and **disabling** auto

fetching, press the  (or  for model 878B) button. When enabled, data will be fetched constantly after every measurement cycle is completed. When disabled, no fetched data will be available.

Note: *Alternatively, auto fetching mode can be disabled when a remote command is sent to the instrument, turning it back into remote mode. In this event, the **[RMT]** indicator will appear on the LCD display, and auto fetching will be disabled automatically. To re-enabled auto fetching again in*

this state, first press the  (or  for model 878B) button once to exit out of remote mode and return to local mode. Then, press the button once more to have it set to auto fetching mode again.

Command Protocols

Overview of Command Type and Format

All commands are entered in either the upper case or the lower case. There are two types of the meter programming commands: IEEE 488 common

commands and Standard Commands for Programmable Instruments (SCPI). Some commands are device-specific to the meter. They are not included in the version 1999.0 of the SCPI standard. However, these commands are designed with the SCPI format in mind and they follow the syntax rules of the standard.

Common Command Format

The IEEE 488 standard defines the common commands as commands that perform functions like reset and system query. Common commands usually come with the asterisk "*" character, and may include parameters. Some examples of Common command like: *IDN?, *GTL, *LLO.

SCPI Command Format and Query Format

The SCPI commands control instrument functions. A subsystem command has a hierarchical structure that usually consists of a top-level (or root) keyword, one or more lower level keywords, and parameters. The following example shows a command and its associated query:

- A. FUNCtion:impa L
Select L as primary parameter
- B. FUNCtion:impa?
Return primary parameter

function is a root level keyword with the second level keyword, impa, and L is the command parameter. The query command ends with a question mark “?”.

Note: SCPI stems from IEEE488.1 and IEEE 488.2. Although the IEEE 488.2 standard addressed some instrument measurements, it principally dealt with common commands and syntax or data formats. Please refer to the IEEE488.2 and SCPI reference manual for more information.

Termination Character

A terminator is a character sent by a host, which identifies the end of a command string. A valid terminator consists of two-byte data: <CR> (Carriage Return, ASC(&H0D)) or <LF> (Line Feed, ASC(&H0A)) or <CR><LF>

Responding Message

Returned result

After the meter executes a query command, the return of the result will be in the following format:

<Result> + <CR> <LF>

For example, in auto fetching mode, the meter will send the measured data automatically when the

measurement cycle is completed. The format of the printed data will be shown as the following:

<Primary measured data, Secondly measured data, Tolerance Result > + <CR> <LF>

Data Types

Returned message is an ASCII string from the meter responding to a query. A query is a command accompanied a “?” mark. Table 4 below explains the different data types.

Table 4 - Data Type of Responded Messages

Data Type	Explanation	Example
<NR1>	An integer	+800,-200,100,-50
<NR2>	This numeric representation has an explicit radix point	+1.56,-0.001,10.5
<NR3>	This representation has an explicit radix point and an exponent	+2.345678E+04 -1.345678E-01
<Boolean>	A parameter for Boolean setting. Always return “0” or “1” for Boolean	ON or OFF

	query command	
<Literal>	A string is used as command parameters with short literal form	HOLD

SCPI Commands

This section described all the SCPI commands supported by the meter. The meter can accept both upper case and lower case commands.

Table 5 - SCPI Symbol Conventions

Text Symbol	Meaning
[]	Option; can be omitted
	Exclusive OR
< >	Defined element
()	Comment
?	Question mark
:	Separated two command keywords

***IDN?**

Description: Queries the instrument ID. Response: <instrument model>, <firmware version>, <serial number>

***LLO**

Local Lockout. This means that all front panel buttons, including the "USB" key is not available.

***GTL**

Go to local. Puts the meter into the local state, clearing the remote state and front panel lockout.

FREQuency Subsystem

FREQuency <value>

Description: Set measurement frequency Parameters: Parameters are 100, 120, 1000, 10000 (<i>879B only</i>) or 100hz,120hz,1khz,10khz (<i>879B only</i>) Example: FREQuency 100hz Set 100Hz frequency

FREQuency?

Description: Query the measurement frequency Response: 100hz, 120hz, 1khz, 10khz (<i>879B only</i>)

FUNCTION subsystem

FUNCTION:impa < L | C | R | Z >

(Z for model 879B only)

Description: Select primary parameter

Example: FUNCTION:impa L
Selects L as primary parameter

FUNCTION:impa?

Description: Query primary parameter

Response: Return L, C, R, Z (*879B only*), NULL

FUNCTION:impb < D | Q | THETA | ESR >

(THETA and ESR for model 879B only)

Description: Select secondly parameter

Example: FUNCTION:impb D
Select D as secondly parameter

FUNCTION:impb?

Description: Query secondly parameter

Response: Return D, Q, THETA (*879B only*),
ESR (*879B only*), NULL

FUNCTION:Equivalent < SERIES | parallel | PAL >

Description:	Set equivalent mode
Parameters:	SERies — serial mode Parallel — parallel mode Pal — parallel mode
Example:	FUNCTION:Equivalent SERIES Set series mode

FUNCTION:Equivalent?

Description:	Query the equivalent mode
Response:	Return "SER" or "PAL" format string

CALCulate subsystem

CALCulate:RELative:STATe < ON | OFF >

Description:	Enable or disable relative function
Example:	CALCulate:RELative:STATe ON

CALCulate:RELative:STATe?

Description:	Query the relative state
Response:	Return ON or OFF

CALCulate:RELative:VALUe?

Description: Query the relative value
Response: Return <NR3> or "-----" format string

CALCulate:TOLerance:STATe < ON | OFF >

Description: Enable or disable tolerance function
Example: CALCulate:TOLerance:STATe ON

CALCulate:TOLerance:STATe?

Description: Query the tolerance state
Response: Return ON or OFF

CALCulate:TOLerance:NOMinal?

Description: Query the nominal value of tolerance
Response: Return <NR3> or "-----" format string

CALCulate:TOLerance:VALUe?

Description: Query the percent value of tolerance
Response: Return <NR3> or "-----" format string

CALCulate:TOLerance:RANGe < 1 | 5 | 10 | 20 >

Description: Set tolerance range
Parameters: 20 (*879B only*)
Example: CALCulate:TOLerance:RANGe 1
Set 1% tolerance range

CALCulate:TOLerance:RANGe?

Description: Query the tolerance range
Response: Return "BIN1", "BIN2", "BIN3",
"BIN4" or "----" format string

CALCulate:RECORDing:STATe < ON | OFF >

Description: Enable or disable recording
function
Example: CALCulate:RECORDing:STATe
ON

CALCulate:RECORDing:STATe?

Description: Query the recording state
Response: Return ON or OFF

CALCulate:RECORDing:MAXimum?

Description: Query the maximum value of
recording function
Response: Return <NR3, NR3> or "-----" format
string

CALCulate:RECORDing:MINimum?

Description: Query the minimum value of
recording function
Response: Return <NR3, NR3> or "-----" format
string

CALCulate:RECOding:AVErAge?

Description: Query the average value of recording function

Response: Return <NR3, NR3> or “-----” format string

CALCulate:RECOding:PRESent?

Description: Query the present value of recording function

Response: Return <NR3, NR3> or “-----” format string

FETCh Subsystem

FETCh?

Description: Returns the primary, secondary display value and tolerance compared result of device’s output buffer.

Response: Return <NR3, NR3, NR1> format string

Example: FETCh?

Summary of Supported SCPI Commands

Table 6 - Summary of SCPI Commands

Command	Parameter	Explanation
FREQuency	<Value>	Set Test Frequency
FREQuency?		Query Test Frequency
FUNcTION		
:impa	<Literal>	Select primary display parameter
:impa?		Query primary display parameter
:impb	<Literal>	Select secondary display parameter
:impb?		Query secondary display parameter
:EQUivalent	<Literal>	Set equivalent mode
:EQUivalent?		Query equivalent mode
CALCulate		
:RELative		
:STATe	<Boolean>	Enable/disable relative function
:STATe?		Query relative state
:VALUe?		Query relative value
:TOLerance		
:STATe	<Boolean>	Enable/disable tolerance function
:STATe?		Query tolerance state
:NOMinal?		Query nominal value of tolerance
:VALUe?		Query percent of tolerance
:RANG	<Value>	Set tolerance range
:RANGe?		Query tolerance range
:RECording		

:STATe	<Boolean>	Enable/disable recording function
:STATe?		Query recording state
:MAXimum?		Query max. value of recording
:MINimum?		Query min. value of recording
:AVERage?		Query average value of recording
:PRESent?		Query present value of recording
FETCH?		Return data any time last reading is valid

Error Codes

In certain situations, errors may occur, and an error code will be displayed on the meter. Below defines the error description based on the error code.

E10: Unknown command

E11: Parameter Error

E12: Syntax Error

SUPPLEMENTAL INFORMATION" section.

Selecting Frequency

To select or change the test frequency, push the



button once. With each press, the test frequency will be indicated on the secondary display of the meter. This will remain displayed until a different function for the secondary display is selected.

The selectable test frequencies for **879B** meter are:
100 Hz, 120 Hz, 1 kHz, and 10 kHz.

The selectable test frequencies for **878B** meter are:
120 Hz and 1 kHz.

Relative Mode

Relative mode is used when the user wants to “zero” the meter based on a reference value or wants to obtain a reading that is relative to a reference value. For example, if test leads are used in the measurement, the user may want to set a reference with the test leads inserted into the input terminals so that any measurements taken will not take into account the test leads.

Setup Relative Mode

To setup the relative mode, simply press the  button once. The value that is on the display will immediately be stored as the “reference” value. This reference value will be used for all measurements so as long as the meter is in relative mode, which is indicated by the “**REL**” indicator on the display.

A common use of relative mode is to “zero” out the meter. With nothing connected to the input sockets

and terminals, simply press the  button once and the meter will “zero” out, meaning all display reading will become 0.

To make measurements within a specific test setup or with test leads, it is recommended that the user first have test leads or wires connected to the meter in the

fashion that they desire. Then, press the  button once to “zero” out the meter as reference. This way, any measurements taken would not be affected by the test leads or setup.

Disable Relative mode

To disable relative mode, simply press the  button once more. The “REL” indicator will disappear, which indicates the relative mode is disabled.

Note: *Changing the primary function, secondary function, or test frequency will automatically disable relative mode.*

Tolerance

The tolerance mode feature is specifically used for component sorting purposes. Users who need to test and sort through a large number of components will find this function quite helpful.

Tolerance Range



The tolerance function is configured primarily by range in percentage, meaning a percentage is used to define whether a measured value is within tolerance or out of tolerance.

(for model 879B) Selectable tolerance range is: **1%**, **5%**, **10%**, and **20%**.

(for model 878B) Selectable tolerance range is: **1%**, **5%**, and **10%**.

Setup Tolerance

1. Select the primary measurement mode based on the type of components to be measured.

This is done by pressing the  (or ) button to configure the desired measurement mode.

Note: *Be sure to select the correct measurement mode, as tolerance mode cannot be activated unless the correct mode is selected. For example, if the component is a capacitor, be sure to select “C” for capacitance. If not, tolerance mode will not be activated following the proceeding steps below.*

2. Insert the component to be used as the “standard” reference value. Another words, insert a known “good” component that will be used for testing against all other components.

(See Figure 6 for illustration)

Note: *The tolerance mode cannot be activated unless the meter senses a component is connected to either the input sockets or terminals.*

WARNING: If the component to be measured is a capacitor, be sure that the capacitor is fully discharged BEFORE inserting it into the input sockets or terminals. For large capacitors, it may take longer periods of time for a full discharge. Inserting a charged or partially charged capacitor into the meter's input sockets or terminals may produce an electric hazard and may also damage the instrument, making it unusable.

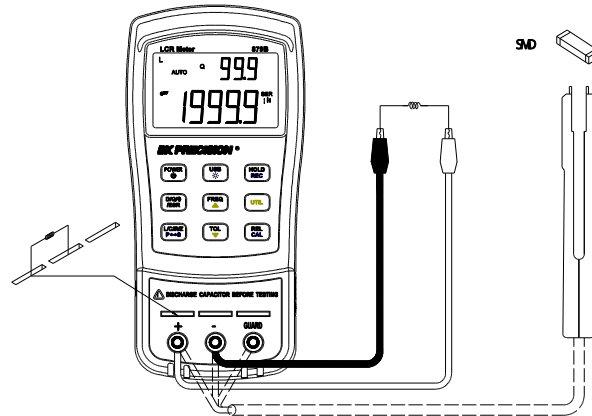



Figure 6 - Inserting Component to Inputs

3. Once the desired measured reading is displayed, press the  button once to store the reading as the “standard” value or test reference value. At this point, the “TOL” will be displayed on the screen, indicating that the tolerance mode is activated.

Note: Any value which appears on the LCD display, such as DH (data hold) or MAX/MIN/AVG, can also be used as the “standard” value or test reference value for sorting components.

4. To select the tolerance range, press the  button once more. For each button press, the meter will cycle through the tolerance range percentage in this order: **1%**, **5%**, **10%**, **20%** (*model 879B only*). These percentage ranges will also be indicated on the LCD display by the indicators “**1%**”, “**5%**”, “**10%**”, or “**20%**” (*model 879B only*) respectively. The component to be tested for will be verified with the tolerance within the selected % of the “standard” value or test reference value (as configured from step 3).
5. Within a few seconds, an audible tone will be heard.

One single “beep” or tone means the component is within tolerance.

Three “beeps” or tone means the component is out of tolerance.



Disable Tolerance Mode

To disable or exit out of tolerance mode, simply press and hold down the  button for two seconds. The “**TOL**” and/or the percentage indicators “**1%**”, “**5%**”, “**10%**”, or “**20%**” (for model 879B only) will disappear on the LCD display.

Note: Changing the primary function, secondary function, or test frequency will automatically disable tolerance mode.

Utility Menu

The LCR meter has a built-in utility menu that allows you to configure some user preferences and settings. The buttons used to set and control the menu are

colored in yellow. They are , , and . User can configure the beep sound, auto

power-off timing, power-up state, and reset instrument to default settings.

Entering Utility Menu

Press and hold down the  button for two seconds or until the primary display shows “**bEEP**”. This indicates the meter is currently in the utility menu.

Configuration and Settings





There are four different menu options and configurable settings under each option. Below is a table that lists these options and settings.

Table 1 - Utility Menu Options and Settings

MENU OPTIONS	SETTINGS / PARAMETERS
bEEP	ON / OFF
AoFF	5 / 15 / 30 / 60 / OFF
PuP	PrE / Set
dEF	yES / NO

The four menu options allow users to control the beep sound setting (bEEP), auto power off setting (AoFF), power-up state settings (PuP), and resetting instrument to default settings (dEF).

By default, the first option after entering the utility menu is “bEEP”. The primary display indicates the menu option, and the secondary display indicates the current settings or parameters configured for the selected option. To change the settings or

parameters, use the  and  arrow keys. To change or select a different menu option, press the  button once. For each  button press, the meter will traverse through each menu options and will repeat itself in the following order:



bEEP → AoFF → PuP → dEF



Note: *The settings and parameters are temporarily “remembered” once the  button is pressed to select a different menu option. To save all settings permanently, exit the menu using the save and exit method. With the exception of “bEEP” and “AoFF” settings, in which case under these settings, changes are temporarily saved even when exiting the menu without saving. (See “Exit Utility Menu” section for details).*

Beep Sound Setting (bEEP)

The “bEEP” menu option allows the user to enable or disable the beep sound for every key press.

Note: This option only disables the beep sound for each key press. It does not disable the beep sound for “**Static Recording**” and “**Tolerance**” mode, as well as the “**auto power-off**” warning.

To turn **ON** the beep, push either the  or  arrow keys until the secondary display shows “**ON**”.

To turn **OFF** the beep, push either the  or  arrow keys until the secondary display shows “**OFF**”.

Default Setting: ON

Auto power-off Setting (AoFF)

The “**AoFF**” menu option allows the user to select the auto power-off timer. This timer is always counting continuously. It resets every time a button is pressed or if an action occurred. If the meter is left untouched or unattended, the timer will count until the configured time is up. This is particularly important if the user wants to preserve battery life or run the meter continuously without interruption.

Note: When the timer has reached the configured time, the meter will make an audible “beep” sound continuously for 10 seconds before auto power-off. To stop the “beep” sound, simply press any button to resume operation and reset the timer count.

The available timer settings are: **5 minutes, 15 minutes, 30 minutes, 60 minutes,** and **off.**

When the primary display shows “**AoFF**”, push the



or button to select the timer setting. The settings will be shown on the secondary display as follows:

Table 2 - Auto Power-off Options

SECONDARY DISPLAY	REPRESENTATION
5	5 minutes
15	15 minutes
30	30 minutes
60	60 minutes
OFF	No timer. Manual power off only

Default Setting: 15

When the auto power-off option is set to any of the configured settings in Table 2 (except for “OFF”), upon exiting the utility menu the LCD display will have a “@OFF” indicator. This means a timer has been set for auto power-off.

Note: When an external 12VDC AC adapter is used to power the instrument, the auto power-off feature will automatically be disabled. This is indicated on the LCD display when the “@OFF” indicator disappears. Under this condition, the meter will remain powered ON continuously. In this state, powering off the instrument would require manually pushing and

holding down the  button for 2 seconds.

When external power is removed, the meter will automatically re-enable auto power-off again and “@OFF” indicator will re-appear if a time has been set from the “AoFF” option of the utility menu.

Power-up State (PuP)

The “**PuP**” menu option allows user to configure the power-up state of the LCR meter, allowing user to restore settings saved into internal EEPROM memory at power-up.

In the utility menu, when the primary display shows “PuP”, there are two settings selectable and shown on the secondary display. “PrE” and “SEt”.

Default Setting: PrE





Storable Settings

- Primary function mode (i.e. L/C/R)
- Test frequency
- Secondary function mode (i.e. D/Q)
- Tolerance mode state
- Reference value for Tolerance mode
- Relative mode state
- Reference value for Relative mode

Configure and Save Power-up State

Follow the below procedure to setup and store a power-up state into internal memory.

1. Before entering into the utility menu, configure all the settings and parameters desired for power up state. Do this by turning on any modes and setting values as desired. (Only the settings listed above in “Storage Settings” are stored). If the meter is currently in the utility menu, exit first and setup the desired

- settings for recalling at power-up. (see “Exit Utility Menu” for details)
2. Once settings are configured, enter/re-enter the utility menu by holding down the  button for 2 seconds.
 3. Traverse through the utility menu until you see “PuP” on the primary display. The secondary display should also show “PrE”.
 4. In order to save the current meter settings for power-up state into internal memory, use either  or  button to change the settings so that the secondary display shows “SEt”.
 5. Press  button to select the next menu option. Once all other utility options are configured, exit the utility menu by holding down  button for 2 seconds.
 6. The meter has now saved all current settings into internal memory. At next power-up, the meter will turn on and recall the saved settings.

Note: The meter allows one set of settings to be stored into memory. Therefore, the same

procedure is used to overwrite previously stored settings into memory.

Prevent Overwrite of Stored Settings

In the utility menu, the “**PuP**” option default setting is always “**PrE**”. This represents “previous settings”. Keeping this setting will prevent the meter from overwriting previously stored settings for power-up state. Therefore, when entering the utility menu, be sure not to change to “**SEt**” to prevent overwriting any previously stored power-up settings.

Reset Default Settings (dEF)

The last option in the utility menu allows you to reset the meter to default settings. When the primary display shows “**dEF**”, the secondary display will show “**NO**” by default. The meter will also default this setting to “**NO**” to prevent accidental reset of instrument settings.

Default Setting: No

To reset the meter to default settings, first select the “**dEF**” menu option by using the use  button to browse through the utility menu. When the primary



display shows “dEF”, either press  or  button to change the setting so that the secondary display shows “yES”. Upon saving and exiting the utility menu, the instrument will automatically reset back to its original settings. Below is a table of all the settings that will be restored.

Table 3 - Instrument Default Settings

Settings	Default Configuration
Primary Function	C (Capacitance)
Secondary Function	None
Measurement Method	SER (Series)
Test Frequency	1 kHz
Beep	On
Auto Power-off	15 (15 minutes)
Power-up State	PrE
Reset Default Settings	No

Note: In the case where under “PuP” option, “SEt” is selected and “dEF” is set to “yES”, the “PuP” setting has priority over the “dEF” setting. This means the instrument will not be set back to default upon saving and exiting the utility menu. Instead, the power-up settings will be stored and will be recalled upon the next power-up of the instrument.





Exit Utility Menu

There are two methods for exiting the utility menu. One saves all the changed settings before exiting, and the other exits the menu without saving any changes.

Saving and Exiting

To save all utility menu option settings and to exit the menu, press and hold down the  button for 2 seconds. After this, the meter will exit the menu, and all settings will be saved.

Exiting without Saving

If user decides to exit the utility menu without making any changes or saving any changes to “**PuP**” or “**dEF**”, it can be done by simply pressing any front panel buttons except , , , and . Note that settings that are changed under “**bEEP**” and “**AoFF**” options are still temporarily set until the next power-up of the instrument.

Parallel and Series Measurement Mode

The LCR meter offers the option to select between parallel or series measurement mode. Depending on which mode is selected, the method to measure the component will be different. Additionally, one measurement mode may provide better accuracies over the other measurement mode depending on the type of component and the value of the component to be tested. For more details, refer to the “

REMOTE COMMUNICATION

The meter has the capability to communicate with a PC over the mini USB interface. Upon installation of a USB driver, the PC can control the instrument over virtual COM (RS-232). The mini USB communication interface of the meter is designed in full duplex and has a 64-byte input and output buffer, making it reliable and efficient for data transmission.

Connecting Instrument to PC

Follow the below procedures for connection setup.

5. Download the USB drivers from
6. With the included mini USB cable, connect the mini USB end to the LCR meter and the other end to an available USB port on the PC (see Figure 14).
7. When Windows recognize the USB connection, do not follow the default Windows driver installation wizard. Simply run the setup file from the downloaded USB drivers and follow the prompt to install drivers.
8. When completed, the computer will recognize the instrument as a USB (virtual COM) device,

USB (Virtual COM) Configuration

The USB will be recognized as a virtual COM on the PC, thus serial port settings must be configured properly for remote communication to be successful. Below are the settings used by the 878B and 879B meters.



- Baudrate: **9600**
- Data bits: **8**
- Parity: **None**
- Stop bits: **1**
- Flow Control: **None**

USB Operation



There are two modes that describe the operation of the meter when it is setup for remote communication. They are remote mode and auto fetching mode.

Remote Mode

Upon connecting to the instrument, sending any commands listed in the “Command Protocols” section will automatically set the LCR meter into remote mode. In remote mode, the LCD display will show the RMT indicator. When this is shown, all front panel

buttons will be disabled, except for the  (or  for model 878B) button.

To exit remote mode and go back to local mode,



press the  (or  for model 878B) button once. The **RMT** indicator will disappear on the LCD display. Pushing the same button once more will put the meter into auto fetching mode, which is described in the next section.

Auto Fetching Mode



When connected to a PC, the meter can be configured to auto-fetching mode. This means, the meter will continuously fetch data to the PC after every measurement cycle is completed. It fetches data from measured readings of primary display and secondary display, as well as tolerance compared results. This mode is useful when doing quick data logging using PC.

Enable/Disable Auto Fetching

To toggle between **enabling** and **disabling** auto

fetching, press the  (or  for model 878B) button. When enabled, data will be fetched constantly after every measurement cycle is completed. When disabled, no fetched data will be available.

Note: Alternatively, auto fetching mode can be disabled when a remote command is sent to the instrument, turning it back into remote mode. In this event, the **[RMT]** indicator will appear on the LCD display, and auto fetching will be disabled automatically. To re-enabled auto fetching again in

this state, first press the  (or  for model 878B) button once to exit out of remote mode and return to local mode. Then, press the button once more to have it set to auto fetching mode again.

Command Protocols

Overview of Command Type and Format

All commands are entered in either the upper case or the lower case. There are two types of the meter programming commands: IEEE 488 common

commands and Standard Commands for Programmable Instruments (SCPI). Some commands are device-specific to the meter. They are not included in the version 1999.0 of the SCPI standard. However, these commands are designed with the SCPI format in mind and they follow the syntax rules of the standard.

Common Command Format

The IEEE 488 standard defines the common commands as commands that perform functions like reset and system query. Common commands usually come with the asterisk "*" character, and may include parameters. Some examples of Common command like: *IDN?, *GTL, *LLO.

SCPI Command Format and Query Format

The SCPI commands control instrument functions. A subsystem command has a hierarchical structure that usually consists of a top-level (or root) keyword, one or more lower level keywords, and parameters. The following example shows a command and its associated query:

- A. FUNCtion:impa L
Select L as primary parameter
- B. FUNCtion:impa?
Return primary parameter

function is a root level keyword with the second level keyword, `impa`, and `L` is the command parameter. The query command ends with a question mark “?”.

Note: *SCPI stems from IEEE488.1 and IEEE 488.2. Although the IEEE 488.2 standard addressed some instrument measurements, it principally dealt with common commands and syntax or data formats. Please refer to the IEEE488.2 and SCPI reference manual for more information.*

Termination Character

A terminator is a character sent by a host, which identifies the end of a command string. A valid terminator consists of two-byte data: `<CR>` (Carriage Return, ASC(&H0D)) or `<LF>` (Line Feed, ASC(&H0A)) or `<CR><LF>`

Responding Message

Returned result

After the meter executes a query command, the return of the result will be in the following format:

`<Result> + <CR> <LF>`

For example, in auto fetching mode, the meter will send the measured data automatically when the

measurement cycle is completed. The format of the printed data will be shown as the following:

<Primary measured data, Secondly measured data, Tolerance Result > + <CR> <LF>

Data Types

Returned message is an ASCII string from the meter responding to a query. A query is a command accompanied a “?” mark. Table 4 below explains the different data types.

Table 4 - Data Type of Responded Messages

Data Type	Explanation	Example
<NR1>	An integer	+800,-200,100,-50
<NR2>	This numeric representation has an explicit radix point	+1.56,-0.001,10.5
<NR3>	This representation has an explicit radix point and an exponent	+2.345678E+04 -1.345678E-01
<Boolean>	A parameter for Boolean setting. Always return “0” or “1” for Boolean	ON or OFF

	query command	
<Literal>	A string is used as command parameters with short literal form	HOLD

SCPI Commands

This section described all the SCPI commands supported by the meter. The meter can accept both upper case and lower case commands.

Table 5 - SCPI Symbol Conventions

Text Symbol	Meaning
[]	Option; can be omitted
	Exclusive OR
< >	Defined element
()	Comment
?	Question mark
:	Separated two command keywords

***IDN?**

Description: Queries the instrument ID. Response: <instrument model>, <firmware version>, <serial number>

***LLO**

Local Lockout. This means that all front panel buttons, including the "USB" key is not available.

***GTL**

Go to local. Puts the meter into the local state, clearing the remote state and front panel lockout.

FREQuency Subsystem

FREQuency <value>

Description: Set measurement frequency Parameters: Parameters are 100, 120, 1000, 10000 (<i>879B only</i>) or 100hz,120hz,1khz,10khz (<i>879B only</i>) Example: FREQuency 100hz Set 100Hz frequency

FREQuency?

Description: Query the measurement frequency Response: 100hz, 120hz, 1khz, 10khz (<i>879B only</i>)

FUNCTION subsystem

FUNCTION:impa < L | C | R | Z > (Z for model 879B only)

Description: Select primary parameter Example: FUNCTION:impa L Selects L as primary parameter

FUNCTION:impa?

Description: Query primary parameter Response: Return L, C, R, Z (879B only), NULL

FUNCTION:impb < D | Q | THETA | ESR > (THETA and ESR for model 879B only)

Description: Select secondly parameter Example: FUNCTION:impb D Select D as secondly parameter

FUNCTION:impb?

Description: Query secondly parameter Response: Return D, Q, THETA (879B only), ESR (879B only), NULL

FUNCTION:Equivalent < SERIES | parallel | PAL >

Description:	Set equivalent mode
Parameters:	SERies — serial mode Parallel — parallel mode Pal — parallel mode
Example:	FUNCTION:Equivalent SERIES Set series mode

FUNCTION:Equivalent?

Description:	Query the equivalent mode
Response:	Return "SER" or "PAL" format string

CALCulate subsystem

CALCulate:RELative:STATe < ON | OFF >

Description:	Enable or disable relative function
Example:	CALCulate:RELative:STATe ON

CALCulate:RELative:STATe?

Description:	Query the relative state
Response:	Return ON or OFF

CALCulate:RELative:VALUe?

Description: Query the relative value
Response: Return <NR3> or "-----" format string

CALCulate:TOLerance:STATe < ON | OFF >

Description: Enable or disable tolerance function
Example: CALCulate:TOLerance:STATe ON

CALCulate:TOLerance:STATe?

Description: Query the tolerance state
Response: Return ON or OFF

CALCulate:TOLerance:NOMinal?

Description: Query the nominal value of tolerance
Response: Return <NR3> or "-----" format string

CALCulate:TOLerance:VALUe?

Description: Query the percent value of tolerance
Response: Return <NR3> or "-----" format string

CALCulate:TOLerance:RANGe < 1 | 5 | 10 | 20 >

Description: Set tolerance range
Parameters: 20 (*879B only*)
Example: CALCulate:TOLerance:RANGe 1
Set 1% tolerance range

CALCulate:TOLerance:RANGe?

Description: Query the tolerance range
Response: Return "BIN1", "BIN2", "BIN3",
"BIN4" or "----" format string

CALCulate:RECORDing:STATe < ON | OFF >

Description: Enable or disable recording
function
Example: CALCulate:RECORDing:STATe
ON

CALCulate:RECORDing:STATe?

Description: Query the recording state
Response: Return ON or OFF

CALCulate:RECORDing:MAXimum?

Description: Query the maximum value of
recording function
Response: Return <NR3, NR3> or "-----" format
string

CALCulate:RECORDing:MINimum?

Description: Query the minimum value of
recording function
Response: Return <NR3, NR3> or "-----" format
string

CALCulate:RECOding:AVERage?

Description: Query the average value of recording function

Response: Return <NR3, NR3> or “-----” format string

CALCulate:RECOding:PRESent?

Description: Query the present value of recording function

Response: Return <NR3, NR3> or “-----” format string

FETCh Subsystem

FETCh?

Description: Returns the primary, secondary display value and tolerance compared result of device’s output buffer.

Response: Return <NR3, NR3, NR1> format string

Example: FETCh?

Summary of Supported SCPI Commands

Table 6 - Summary of SCPI Commands

Command	Parameter	Explanation
FREQuency	<Value>	Set Test Frequency
FREQuency?		Query Test Frequency
FUNcTION		
:impa	<Literal>	Select primary display parameter
:impa?		Query primary display parameter
:impb	<Literal>	Select secondary display parameter
:impb?		Query secondary display parameter
:EQUivalent	<Literal>	Set equivalent mode
:EQUivalent?		Query equivalent mode
CALCulate		
:RELative		
:STATe	<Boolean>	Enable/disable relative function
:STATe?		Query relative state
:VALUe?		Query relative value
:TOLerance		
:STATe	<Boolean>	Enable/disable tolerance function
:STATe?		Query tolerance state
:NOMinal?		Query nominal value of tolerance
:VALUe?		Query percent of tolerance
:RANG	<Value>	Set tolerance range
:RANGe?		Query tolerance range
:RECording		

:STATe	<Boolean>	Enable/disable recording function
:STATe?		Query recording state
:MAXimum?		Query max. value of recording
:MINimum?		Query min. value of recording
:AVERage?		Query average value of recording
:PRESent?		Query present value of recording
FETCH?		Return data any time last reading is valid

Error Codes

In certain situations, errors may occur, and an error code will be displayed on the meter. Below defines the error description based on the error code.

E10: Unknown command

E11: Parameter Error

E12: Syntax Error

SUPPLEMENTAL INFORMATION” section.

Default Settings

For **Capacitance** and **Resistance** measurements, the default measurement mode is **parallel**.

For **Inductance** measurements, the default measurement mode is **series**.

Selecting Measurement Mode

The measurement mode of the meter is displayed by the indicators “**SER**” or “**PAR**” on the LCD screen. “**SER**” means meter is in series measurement mode. “**PAR**” means meter is in parallel measurement mode. To toggle between the two modes, press and hold



down  (or  for model 878B) button for 2 seconds. The indicators on the display should toggle between “**SER**” and “**PAR**”.

Calibration

Calibration is available on all modes. It is recommended that to achieve optimal readings,

calibration should be done before making any measurements.

To enter calibration mode, simply press and hold

down the  button for 2 seconds. A calibration prompt will be displayed. There are two types of calibration available. One is the open circuit calibration. The other is the short circuit calibration. To exit calibration mode, simply press and hold down the  button for 2 seconds again.

Open Calibration

Open calibration can be done when meter first enters into calibration mode. If the input sockets or terminals have nothing connected, the display should show Figure 7. Also, “REL” indicator will be blinking on the display. This is to prompt the user that the meter is waiting for an action. At this point, open calibration

will be done when the  button is pressed once. Within a few seconds, the meter will return to normal display and meter will be calibrated based on the test frequency and settings selected prior to entering the calibration mode.



Figure 7 - Open Calibration

Short Calibration

Short calibration can be done when meter first enters into calibration mode. If the input sockets or terminals have nothing connected, the display will be like Figure 7. For short calibration, simply put a shorting bar or a short piece of conductive metal (i.e. paper clip) across the "+" and "-" input sockets or terminals. Within 2 seconds, the meter will display the same screen as Figure 8, which prompts for a "short". Also, "REL" indicator will be blinking on the display. This is to prompt the user that the meter is waiting for an action. At this point, short calibration will be done when the



button is pressed once. Within a few seconds, the meter will return to normal display and meter will

be calibrated based on the test frequency and settings selected prior to entering the calibration mode.

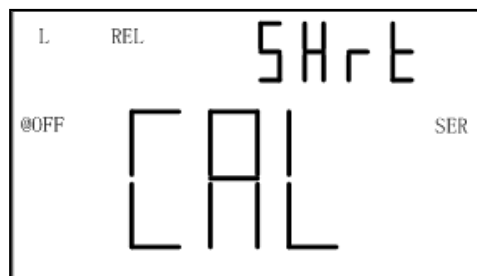



Figure 8 - Short Calibration

Quick Procedure

Below is an example of steps to follow to do both open and short calibration.

1. Select the primary function mode for measurement (i.e. L/C/R/Z).
2. Select the test frequency for measurement.
3. Select the measurement mode (i.e. Series or Parallel)
4. Once all settings are configured, hold down  button for 2 seconds to enter into calibration mode.
5. First, do open calibration. Follow instructions under "Open Calibration" section.

6. Next, do short calibration. Follow instructions under “Short Calibration” section.
7. Now, the meter should go back to normal display and user may proceed to take measurements of components.



Recommendations

To achieve optimal measurement results, both open and short calibration should be done. It is highly recommended to calibrate extremely high or low values for L, C, R and Z before making precision measurements.

Notes:

1. *If test frequency is changed, calibration should be done again before making precision measurements. Once calibration is done on a selected test frequency, calibration data will remain until power off.*
2. *Either open or short calibration is not associated with measurement function, therefore changing the test function does not require re-calibration.*
3. *Re-calibration may be necessary depending on many factors such as prolonged use, changing environments, and contact variation (i.e. alligator test leads or socket contacts).*

USB

The USB button  (or  for model 878B) are used for remote communication. See “

REMOTE **COMMUNICATION**" section for details.

Automatic Fuse Detection

The LCR meter has an internal fuse that protects the inputs from severely damaging the instrument. When the meter detects that the protective fuse is open, the **"FUSE"** indicator will appear on the primary display (see Figure 9) and an internal "beep" will sound continuously. In this situation, none of the function buttons can be operated and all other meter functions will be disabled.

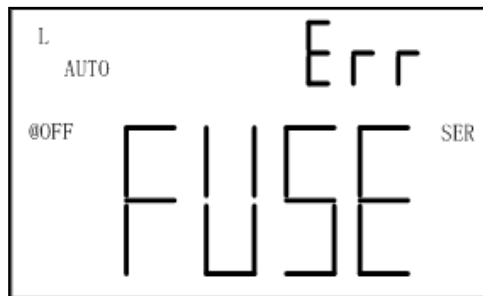



Figure 9 - Fuse Display

In the event that the above screen is displayed, a fuse replacement is required. Turn off the meter by

pressing and holding down the  button for 2 seconds. If this does not power off the meter, remove external AC adapter if that is used and/or remove the battery from the battery compartment. Refrain from further operation until fuse is replaced. Please contact B&K Precision for assistance.

QUICK START GUIDE







CAUTION 

- Do not measure a capacitor that is not fully discharged. Connecting a charged or partially charged capacitor to the input terminals will damage the instrument.
- When measuring within a circuit, the circuit must be de-energized before connecting the test leads.
- When used in a dusty environment, the instrument should be wiped and cleaned regularly.
- Do not leave the instrument exposed to direct heat from the sun for long periods of time.
- Before removing the cover, ensure that the instrument is disconnected from any circuit and is powered OFF.

Note:

To achieve optimum precision for all L, C, and R measurements at either the highest or lowest ranges, calibrate the meter before testing. See "Calibration" section for details.

Inductance Measurement

1. Press down  button for one second to turn on the meter.
2. Press  (or  for model 878B) button until "L" is displayed on the screen to select inductance measurement.
3. Insert an inductor into either the input sockets or connect alligator leads into the banana jack input terminals and connect the clips to the component leads as illustrated in Figure 10.
4. Press  button until the desired test frequency is displayed on screen.
5. Press  (or  for model 878B) button to select between D factor, Q factor, θ angle, or

ESR measurement for secondary display. (θ and ESR function for model 879B only)

6. Read the display readings for inductance measured values and selected measured values on secondary display.

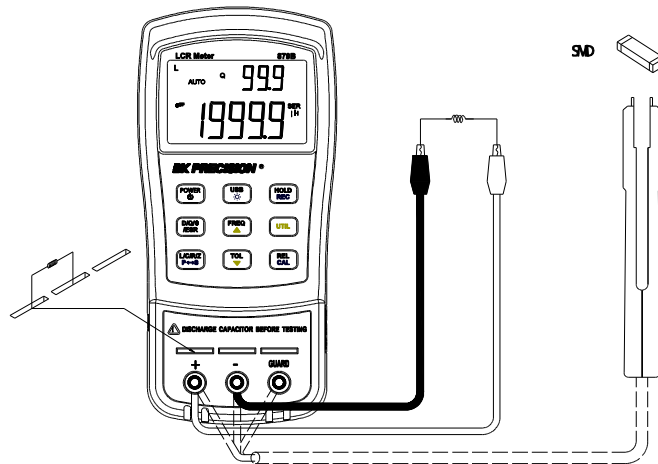









Figure 10 - Inductance Measurement Setup

Capacitance Measurement

 **WARNING** Fully discharge capacitor **BEFORE** inserting it into the instrument. Failure to do this may result in damage to the meter and may cause electrical hazards.

1. Press down  button for one second to turn on the meter.
2. Press  (or  for model 878B) button until “C” is on the screen to select capacitance measurement.
3. **CAUTION: BEFORE inserting a capacitor or capacitive component into the input sockets or terminals, be sure to fully discharge the component. Some larger capacitive components may take longer to discharge. In these cases, please allot enough time for a full discharge. If proper discharging of the component is not done correctly, it will damage the input terminals of the meter.**
4. Insert the DISCHARGED capacitor or capacitive component into the input sockets or connect alligator leads into the banana jack input terminals and connect the clips to the component leads as illustrated in Figure 11.

5. Press  button until the desired test frequency is displayed on screen.
6. Press  (or  for model 878B) button to select between D factor, Q factor, θ angle, or ESR measurement for secondary display. (θ and ESR function for model 879B only).
7. Read the display readings for capacitance measured values and selected measured values on secondary display.

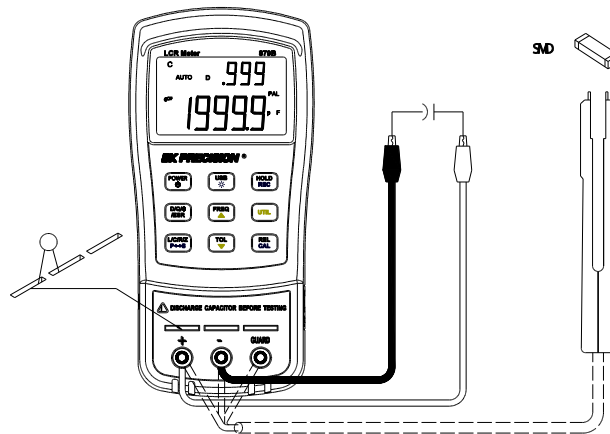





Figure 11 - Capacitance Measurement Setup

Resistance Measurement

1. Press down  button for one second to turn on the meter.
2. Press  (or ) button until "R" is on the screen to select resistance measurement.
3. Insert resistor or resistive component into the input sockets or connect alligator leads into the banana jack input terminals and connect the clips to the component leads as illustrated in Figure 12.
4. Press  button until the desired test frequency is displayed on screen.

Note: This meter does not provide a DC resistance measurement of the component. It uses an AC signal for measurement. For this reason, some applications or device under test may not give correct readings if they are designed for measurement in DC.

5. Read the display readings for resistance measured values.

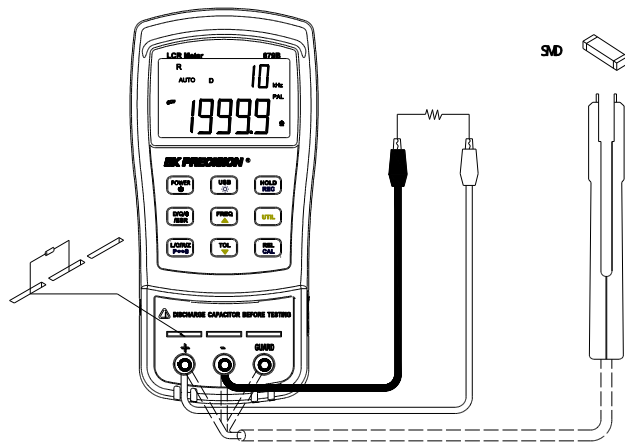





Figure 12 - Resistance Measurement Setup

Impedance Measurement (Model 879B only)

1. Press down  button for one second to turn on the meter.
2. Press  button until “Z” is on the screen to select impedance measurement.

3. Insert component into the input sockets or connect alligator leads into the banana jack input terminals and connect the clips to the component leads as illustrated in Figure 13.
4. Press  button until the desired test frequency is displayed on screen.
5. Read the display readings for impedance measured values.

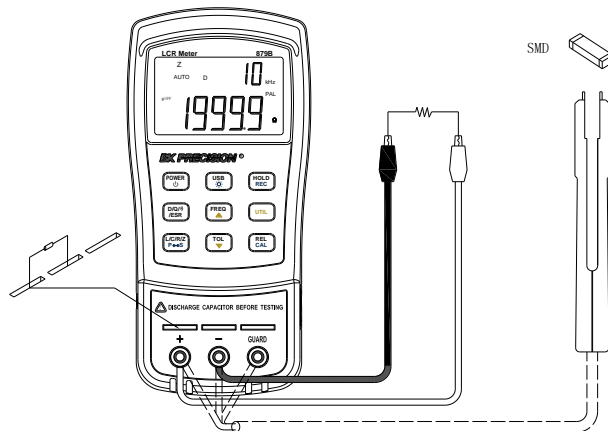

Figure 13 - Impedance Measurement Setup

REMOTE COMMUNICATION

The meter has the capability to communicate with a PC over the mini USB interface. Upon installation of a USB driver, the PC can control the instrument over virtual COM (RS-232). The mini USB communication interface of the meter is designed in full duplex and has a 64-byte input and output buffer, making it reliable and efficient for data transmission.

Connecting Instrument to PC

Follow the below procedures for connection setup.

9. Download the USB drivers from [www.globaltestsupply.com](#)
10. With the included mini USB cable, connect the mini USB end to the LCR meter and the other end to an available USB port on the PC (see Figure 14).
11. When Windows recognize the USB connection, do not follow the default Windows driver installation wizard. Simply run the setup file from the downloaded USB drivers and follow the prompt to install drivers.
12. When completed, the computer will recognize the instrument as a USB (virtual COM) device, meaning it will be detected as a serial COM

port. Windows will automatically assign a COM port to the instrument. Please verify which COM port Windows has assigned by going into “Device Manager”.

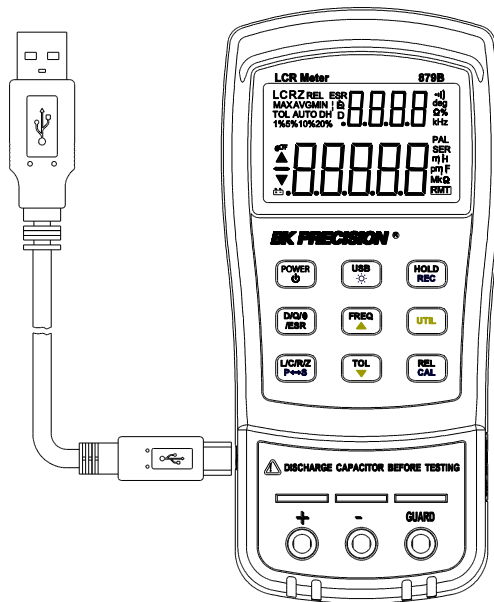

Figure 14 - USB Connection

USB (Virtual COM) Configuration

The USB will be recognized as a virtual COM on the PC, thus serial port settings must be configured properly for remote communication to be successful. Below are the settings used by the 878B and 879B meters.



- Baudrate: **9600**
- Data bits: **8**
- Parity: **None**
- Stop bits: **1**
- Flow Control: **None**

USB Operation



There are two modes that describe the operation of the meter when it is setup for remote communication. They are remote mode and auto fetching mode.

Remote Mode

Upon connecting to the instrument, sending any commands listed in the “Command Protocols” section will automatically set the LCR meter into remote mode. In remote mode, the LCD display will show the RMT indicator. When this is shown, all front panel

buttons will be disabled, except for the  (or  for model 878B) button.

To exit remote mode and go back to local mode,



press the  (or  for model 878B) button once. The **RMT** indicator will disappear on the LCD display. Pushing the same button once more will put the meter into auto fetching mode, which is described in the next section.

Auto Fetching Mode



When connected to a PC, the meter can be configured to auto-fetching mode. This means, the meter will continuously fetch data to the PC after every measurement cycle is completed. It fetches data from measured readings of primary display and secondary display, as well as tolerance compared results. This mode is useful when doing quick data logging using PC.

Enable/Disable Auto Fetching

To toggle between **enabling** and **disabling** auto

fetching, press the  (or  for model 878B) button. When enabled, data will be fetched constantly after every measurement cycle is completed. When disabled, no fetched data will be available.

Note: *Alternatively, auto fetching mode can be disabled when a remote command is sent to the instrument, turning it back into remote mode. In this event, the **[RMT]** indicator will appear on the LCD display, and auto fetching will be disabled automatically. To re-enabled auto fetching again in*

this state, first press the  (or  for model 878B) button once to exit out of remote mode and return to local mode. Then, press the button once more to have it set to auto fetching mode again.

Command Protocols

Overview of Command Type and Format

All commands are entered in either the upper case or the lower case. There are two types of the meter programming commands: IEEE 488 common

commands and Standard Commands for Programmable Instruments (SCPI). Some commands are device-specific to the meter. They are not included in the version 1999.0 of the SCPI standard. However, these commands are designed with the SCPI format in mind and they follow the syntax rules of the standard.

Common Command Format

The IEEE 488 standard defines the common commands as commands that perform functions like reset and system query. Common commands usually come with the asterisk "*" character, and may include parameters. Some examples of Common command like: *IDN?, *GTL, *LLO.

SCPI Command Format and Query Format

The SCPI commands control instrument functions. A subsystem command has a hierarchical structure that usually consists of a top-level (or root) keyword, one or more lower level keywords, and parameters. The following example shows a command and its associated query:

- A. FUNCtion:impa L
Select L as primary parameter
- B. FUNCtion:impa?
Return primary parameter

function is a root level keyword with the second level keyword, `impa`, and `L` is the command parameter. The query command ends with a question mark “?”.

Note: *SCPI stems from IEEE488.1 and IEEE 488.2. Although the IEEE 488.2 standard addressed some instrument measurements, it principally dealt with common commands and syntax or data formats. Please refer to the IEEE488.2 and SCPI reference manual for more information.*

Termination Character

A terminator is a character sent by a host, which identifies the end of a command string. A valid terminator consists of two-byte data: `<CR>` (Carriage Return, ASC(&H0D)) or `<LF>` (Line Feed, ASC(&H0A)) or `<CR><LF>`

Responding Message

Returned result

After the meter executes a query command, the return of the result will be in the following format:

`<Result> + <CR> <LF>`

For example, in auto fetching mode, the meter will send the measured data automatically when the

measurement cycle is completed. The format of the printed data will be shown as the following:

<Primary measured data, Secondly measured data, Tolerance Result > + <CR> <LF>

Data Types

Returned message is an ASCII string from the meter responding to a query. A query is a command accompanied a “?” mark. Table 4 below explains the different data types.

Table 4 - Data Type of Responded Messages

Data Type	Explanation	Example
<NR1>	An integer	+800,-200,100,-50
<NR2>	This numeric representation has an explicit radix point	+1.56,-0.001,10.5
<NR3>	This representation has an explicit radix point and an exponent	+2.345678E+04 -1.345678E-01
<Boolean>	A parameter for Boolean setting. Always return “0” or “1” for Boolean	ON or OFF

	query command	
<Literal>	A string is used as command parameters with short literal form	HOLD

SCPI Commands

This section described all the SCPI commands supported by the meter. The meter can accept both upper case and lower case commands.

Table 5 - SCPI Symbol Conventions

Text Symbol	Meaning
[]	Option; can be omitted
	Exclusive OR
< >	Defined element
()	Comment
?	Question mark
:	Separated two command keywords

***IDN?**

Description: Queries the instrument ID. Response: <instrument model>, <firmware version>, <serial number>

***LLO**

Local Lockout. This means that all front panel buttons, including the "USB" key is not available.

***GTL**

Go to local. Puts the meter into the local state, clearing the remote state and front panel lockout.

FREQuency Subsystem

FREQuency <value>

Description: Set measurement frequency Parameters: Parameters are 100, 120, 1000, 10000 (<i>879B only</i>) or 100hz,120hz,1khz,10khz (<i>879B only</i>) Example: FREQuency 100hz Set 100Hz frequency

FREQuency?

Description: Query the measurement frequency Response: 100hz, 120hz, 1khz, 10khz (<i>879B only</i>)

FUNCTION subsystem

FUNCTION:impa < L | C | R | Z >

(Z for model 879B only)

Description: Select primary parameter

Example: FUNCTION:impa L
Selects L as primary parameter

FUNCTION:impa?

Description: Query primary parameter

Response: Return L, C, R, Z (*879B only*), NULL

FUNCTION:impb < D | Q | THETA | ESR >

(THETA and ESR for model 879B only)

Description: Select secondly parameter

Example: FUNCTION:impb D
Select D as secondly parameter

FUNCTION:impb?

Description: Query secondly parameter

Response: Return D, Q, THETA (*879B only*),
ESR (*879B only*), NULL

FUNCTION:Equivalent < SERIES | parallel | PAL >

Description:	Set equivalent mode
Parameters:	SERies — serial mode Parallel — parallel mode Pal — parallel mode
Example:	FUNCTION:Equivalent SERIES Set series mode

FUNCTION:Equivalent?

Description:	Query the equivalent mode
Response:	Return "SER" or "PAL" format string

CALCulate subsystem

CALCulate:RELative:STATe < ON | OFF >

Description:	Enable or disable relative function
Example:	CALCulate:RELative:STATe ON

CALCulate:RELative:STATe?

Description:	Query the relative state
Response:	Return ON or OFF

CALCulate:RELative:VALUe?

Description: Query the relative value
Response: Return <NR3> or "-----" format string

CALCulate:TOLerance:STATe < ON | OFF >

Description: Enable or disable tolerance function
Example: CALCulate:TOLerance:STATe ON

CALCulate:TOLerance:STATe?

Description: Query the tolerance state
Response: Return ON or OFF

CALCulate:TOLerance:NOMinal?

Description: Query the nominal value of tolerance
Response: Return <NR3> or "-----" format string

CALCulate:TOLerance:VALUe?

Description: Query the percent value of tolerance
Response: Return <NR3> or "-----" format string

CALCulate:TOLerance:RANGe < 1 | 5 | 10 | 20 >

Description: Set tolerance range
Parameters: 20 (*879B only*)
Example: CALCulate:TOLerance:RANGe 1
Set 1% tolerance range

CALCulate:TOLerance:RANGe?

Description: Query the tolerance range
Response: Return "BIN1", "BIN2", "BIN3",
"BIN4" or "----" format string

CALCulate:RECORDing:STATe < ON | OFF >

Description: Enable or disable recording
function
Example: CALCulate:RECORDing:STATe
ON

CALCulate:RECORDing:STATe?

Description: Query the recording state
Response: Return ON or OFF

CALCulate:RECORDing:MAXimum?

Description: Query the maximum value of
recording function
Response: Return <NR3, NR3> or "-----" format
string

CALCulate:RECORDing:MINimum?

Description: Query the minimum value of
recording function
Response: Return <NR3, NR3> or "-----" format
string

CALCulate:RECOding:AVERage?

Description: Query the average value of recording function

Response: Return <NR3, NR3> or “-----” format string

CALCulate:RECOding:PRESent?

Description: Query the present value of recording function

Response: Return <NR3, NR3> or “-----” format string

FETCh Subsystem

FETCh?

Description: Returns the primary, secondary display value and tolerance compared result of device’s output buffer.

Response: Return <NR3, NR3, NR1> format string

Example: FETCh?

Summary of Supported SCPI Commands

Table 6 - Summary of SCPI Commands

Command	Parameter	Explanation
FREQuency	<Value>	Set Test Frequency
FREQuency?		Query Test Frequency
FUNcTION		
:impa	<Literal>	Select primary display parameter
:impa?		Query primary display parameter
:impb	<Literal>	Select secondary display parameter
:impb?		Query secondary display parameter
:EQUivalent	<Literal>	Set equivalent mode
:EQUivalent?		Query equivalent mode
CALCulate		
:RELative		
:STATe	<Boolean>	Enable/disable relative function
:STATe?		Query relative state
:VALUe?		Query relative value
:TOLerance		
:STATe	<Boolean>	Enable/disable tolerance function
:STATe?		Query tolerance state
:NOMinal?		Query nominal value of tolerance
:VALUe?		Query percent of tolerance
:RANG	<Value>	Set tolerance range
:RANGe?		Query tolerance range
:RECording		

:STATe	<Boolean>	Enable/disable recording function
:STATe?		Query recording state
:MAXimum?		Query max. value of recording
:MINimum?		Query min. value of recording
:AVERage?		Query average value of recording
:PRESent?		Query present value of recording
FETCH?		Return data any time last reading is valid

Error Codes

In certain situations, errors may occur, and an error code will be displayed on the meter. Below defines the error description based on the error code.

- E10: Unknown command
- E11: Parameter Error
- E12: Syntax Error

SUPPLEMENTAL INFORMATION

This section provides supplemental information for user consideration when operating the LCR meters. Some recommendations and explanations are provided to help aid in the use of some functions and features, in which can help the user gain optimal and accurate measurement results.

Selecting Test Frequency

Test frequency can greatly affect the results of measurement reading, especially when measuring inductors and capacitors. This section provides some recommendations and suggestions to consider.

Capacitance

When measuring capacitance selecting, the right frequency is important in obtaining the most accurate measurement results. Generally, a 1 kHz test frequency is used to measure capacitors that are 0.01 μF or smaller. For capacitors that are 10 μF or larger, a lower frequency of 120 Hz is used. Following this trend, high test frequencies are best for testing very low capacitance components. For large capacitance components, low frequency would be optimal. For

example, if the capacitance of the component is to be in the mF range, than selecting 100 Hz or 120 Hz for test frequency would give much better results. The results will also be obvious because if the same component was tested with 1 kHz or 10 kHz, the measured readings may look erroneous on the display.

In all cases, it is best to check with the manufacturer's data sheet in order to determine the best test frequency to use for measurement.

Inductance

Typically, a 1 kHz test frequency is used to measure inductors that are used in audio and RF circuits. This is because these components operate at higher frequencies and require that they be measured at higher frequencies such as 1 kHz or 10 kHz. However, a 120 Hz test signal is used to measure inductors that are used for applications such as filter chokes in power supplies, in which are typically operated at 60 Hz AC (in U.S.) with 120 Hz filter frequencies.

In general, inductors below 2 mH should be measured at 1 kHz frequency while inductors above 200 H should be measured at 120 Hz.

In all cases, it is best to check with the manufacturer's data sheet in order to determine the best test frequency to use for measurement.

Selecting Series or Parallel Mode

Just as test frequency can greatly affect measurement results, selecting between series or parallel measurement mode can also affect the accuracy of the meter, especially for capacitive and inductive components. Below are some recommendations to consider.

Capacitance

For most capacitance measurement, selecting **parallel** mode is the best. Hence, the meter defaults to this mode when selecting capacitance mode. Most capacitors have very low dissipation factor (high internal resistance) compared to the impedance of the capacitance. In these cases, the paralleled internal resistance has negligible impact upon the measurement.

Though in some cases, **series** mode would be preferred. For instance, measuring a large capacitor would require using series mode for optimal reading. Otherwise, the meter may show the reading results as

out of accuracy or erroneous. Series mode is use because large capacitors often have higher dissipation factor and lower internal resistance.

Inductance

For most inductance measurement, selecting **series** mode is the best. Hence, the meter defaults to this mode when selecting inductance mode. This is because in this mode, accurate Q (quality factor) reading can be obtained from reading low Q inductors and ohmic losses are significant.

Though in some cases, **parallel** mode would be preferred. For example, iron core inductors operating at higher frequencies where hysteresis and eddy currents become significant would require measurement in parallel mode for optimal results.

Accuracy Discrepancies

In some special cases, inaccuracies may occur in the measurement of capacitive, inductive, and resistive components.

Capacitance

When measuring capacitors, it is always most desirable if the dissipation factor is low. Electrolytic capacitors inherently have a higher dissipation factor due to their normally high internal leakage characteristics. In some cases, if the D (dissipation factor) is excessive, measurement accuracy may degrade and even read out of specification.

Inductance

Some inductors are intended to operate at a certain DC bias to achieve a certain inductance value. However, the 878B and 879B LCR meters cannot produce such biasing scheme and external biasing should not be attempted because external power would be applied to the instrument and cause serious damage to the meter. Therefore, in some cases, measured inductance reading may not agree with manufacturer's specification. It is important to check if specification pertains to DC biasing or not.

Resistance

When measuring resistance of devices, it is important to know that there are two types or ways of measurement. One type is DC resistance measurement. Another type is AC resistance measurement. The 879B and 878B uses AC resistance measurement method and does not

provide an option for DC resistance measurements. Therefore, when measuring a resistive component that is designed to be measured with DC, readings will be incorrect or inaccurate. Before using the meter to measure resistance, please verify whether the DUT (device under test) requires DC or AC resistance measurement method. Depending on the method, results will vary greatly.

Guard Terminal

One of the input sockets and terminals is labeled as “**GUARD**”. This terminal does not have to be used in all instances for the meter to make measurements. But in some instances, it is very useful. Guard terminal generally serves two purposes.

If user is using test leads, the guard terminal can be used to connect to the shielding of the test leads. Doing so can be useful when making large resistive component measurements. For example, when measuring a 10 M Ω resistor with test leads, at the high range the reading may seem to be unstable as a few digits may continuously be changing. Having the shield of the test leads connected to the guard terminal will help stabilize the reading in some instances.

Guard terminal is also used to minimize noise and to help minimize parasitic effects coming from the component to be measured, thus allowing high precision results.

SPECIFICATIONS

Below are some remarks in regards to all specifications pertaining to both 878B and 879B LCR meters.

*Specifications are subject to change without notice.

Notes:

1. Measurement performed at the test socket.
2. Measurements performed after correct open and short calibration.
3. DUT and test leads must be properly shielded to guard if necessary.
4. Based after 30 minutes of warm up time and operated at 23 °C + 5 °C, <75% R.H.
5. Q value is the reciprocal of DF.
6. Accuracies based within 10% to 100% of full scale of range; values outside of range should be used as reference only.
7. Based on battery powered operation.
8. --- means parallel or series measurement mode.

General Specifications

Items	879B	878B
Measurement Parameters	L/C/R/Z/D/Q/θ/ESR	L/C/R/D/Q
Test Frequency Accuracy is 0.02% of actual frequency	100 Hz, 120 Hz, 1 kHz, 10 kHz (test setting)	120 Hz, 1 KHz (test setting)
	100Hz, 120.048Hz, 1 kHz, 10 kHz (actual frequency)	120.048 Hz, 1 kHz (actual frequency)
Tolerance Mode	1%, 5%, 10%, 20%	1%, 5%, 10%
Backlit Display	Yes	None
Test Signal Level	≈ 0.6 Vrms	
Measuring Circuit Mode	Series mode / Parallel mode	
Basic accuracy	0.5%	
Ranging Mode	Auto	
Measuring Terminals	3 terminals with sockets	
Measurement Rate	1.5 reading/second (range auto search not included)	
Response Time	Response Time: ≈680 ms/DUT	
Auto Power-Off	5, 15, 30, 60 mins, None	
Operation Temperature	32 °F to 104 °F(0 °C to 40 °C); 0-70 % R.H.	
Storage Temperature	-4 ° F to 122 °F (-20 °C to +50 °C); 0-80 % R.H.	
Low Battery Indication	≈ 6.8 V	
Battery Life	≈16 hours using Alkaline Battery @ 1 kHz with 100 Ω DUT, with backlight	

	off
Power Consumption	≈ 28 mA (under full power battery) for operation/ 2 μA after Power-off.
Power Requirements	1) DC 9V Battery 2)Ext. AC Adapter: DC 12 Vmin –15 Vmax. (Load 50 mA Min.)
Dimensions (L/W/H)	7.5 x 3.5 x 1.6" (190 x 90 x 41 mm)
Weight	0.7 lbs. (330 grams)

Accuracy Specifications

Inductance

Frequency = 100 Hz*/120 Hz

Range	Max Display	Lx Accuracy	DF(Dx <0.5)	Measurement Mode
1000 H	1000.0 H	1.5% ± 3 digits	1.5% ± 50 digits	Parallel
400 H	399.99 H	0.7% ± 2 digits	0.7% ± 50 digits	Parallel
40 H	39.999 H	0.7% ± 2 digits	0.7% ± 50 digits	---
4000 mH	3999.9 mH	0.5% ± 1 digits	0.5% ± 50 digits	Series
400 mH	399.99 mH	0.6% ± 2 digits	0.6% ± 50 digits	Series
40 mH	39.999 mH	0.9% ± 2 digits	0.9% ± 50 digits	Series
4 mH	3.9999 mH	2.8% ± 3 digits	2.8% ± 50 digits	Series

Frequency = 1 kHz

Range	Max Display	Lx Accuracy	DF(Dx <0.5)	Measurement Mode
100 H	100.00 H	1.5% ± 3 digits	1.5% ± 50 digits	Parallel
40 H	39.999 H	0.7% ± 2 digits	0.7% ± 50 digits	Parallel
4000 mH	3999.9 mH	0.7% ± 2 digits	0.7% ± 50 digits	---
400 mH	399.99 mH	0.5% ± 1 digits	0.5% ± 50 digits	Series
40 mH	39.999 mH	0.6% ± 2 digits	0.6% ± 50 digits	Series
4000 µH	3999.9 µH	0.9% ± 2 digits	0.9% ± 50 digits	Series
400 µH	399.9 µH	2.8% ± 3 digits	2.8% ± 50 digits	Series

Frequency = 10 kHz*

Range	Max Display	Lx Accuracy	DF(Dx <0.5)	Measurement Mode
1000 mH	1000.0 mH	1.5% ± 3 digits	1.5% ± 50 digits	Parallel
400 mH	399.99 mH	0.7% ± 2 digits	0.7% ± 50 digits	---
40 mH	39.999 mH	0.5% ± 1 digits	0.5% ± 50 digits	Series
4000 µH	3999.9 µH	0.6% ± 2 digits	0.6% ± 50 digits	Series

400 μ H	399.99 μ H	0.9% \pm 2 digits	0.9% \pm 50 digits	Series
40 μ H	39.99 μ H	2.8% \pm 3 digits	2.8% \pm 50 digits	Series

Capacitance

Frequency = 100 Hz*/120 Hz

Range	Max Display	Cx Accuracy	DF(Dx <0.5)	Measurement Mode
20 mF	20.000 mF	8% \pm 3 digits	8% \pm 500 digits	Series
4000 μ F	3999.9 μ F	2% \pm 2 digits	2% \pm 500 digits	Series
400 μ F	399.99 μ F	0.7% \pm 2 digits	0.7% \pm 50 digits	Series
40 μ F	39.999 nF	0.5% \pm 1 digits	0.5% \pm 50 digits	Series
4000 nF	3999.9 nF	0.5% \pm 1 digits	0.5% \pm 50 digits	---
400 nF	399.99 nF	0.5% \pm 2 digits	0.5% \pm 50 digits	---
40 nF	39.999 nF	0.7% \pm 1 digits	0.7% \pm 50 digits	Parallel
4 nF	3.9999 nF	2.5% \pm 2 digits	2.5% \pm 50 digits	Parallel

Frequency = 1 kHz

Range	Max Display	Cx Accuracy	DF(Dx <0.5)	Measurement Mode
1000 μ F	1000.0 μ F	3.7% \pm 3 digits	3.7% \pm 50 digits	Series
400 μ F	399.99 μ F	2% \pm 2 digits	2% \pm 50 digits	Series
40 μ F	39.999 μ F	0.7% \pm 2 digits	0.7% \pm 50 digits	Series
4000 nF	3999.9 nF	0.5% \pm 1 digit	0.5% \pm 50 digit	Series
400 nF	399.99 nF	0.5% \pm 2 digits	0.5% \pm 50 digits	---
40 nF	39.999 nF	0.5% \pm 2 digits	0.5% \pm 50 digits	---
4000 pF	3999.9 pF	0.7% \pm 2 digits	0.7% \pm 50 digits	Parallel
400 pF	399.9 pF	2.5% \pm 2 digits	2.5% \pm 50 digits	Parallel

Frequency = 10 kHz*

Range	Max Display	Cx Accuracy	DF(Dx <0.5)	Measurement Mode
100 μ F	100.00 μ F	3.9% \pm 5 digits	3.9% \pm 50 digits	Series
40 μ F	39.999 μ F	3.7% \pm 3 digits	3.7% \pm 50 digits	Series
4000 nF	3999.9 nF	0.7% \pm 2 digits	0.7% \pm 50 digits	Series

400 nF	399.99 nF	0.5% ± 2 digits	0.5% ± 50 digits	Series
40 nF	39.999 nF	0.5% ± 1 digit	0.5% ± 50 digit	---
4000 pF	3999.9 nF	0.5% ± 2 digits	0.5% ± 50 digits	---
400 pF	399.99 pF	0.7% ± 2 digits	0.7% ± 50 digits	Parallel
40 pF	39.99 pF	2.5% ± 2 digits	2.5% ± 50 digits	Parallel

Resistance/Impedance*

Frequency = 100 Hz*/120 Hz/ 1 kHz/10 kHz*

Range	Max Display	R/Zx Accuracy	Θ* Accuracy	Measurement Mode
10 MΩ	10.000 MΩ	5.5% ± 3 digits	±3.2°	Parallel
4000 kΩ	3999.9 kΩ	2.5% ± 2 digits	±1.5°	Parallel
400 kΩ	399.99 kΩ	0.7% ± 2 digits	±0.4°	Parallel
40 kΩ	39.999 kΩ	0.5% ± 2 digits	±0.3°	---
4000 Ω	3999.9 Ω	0.5% ± 2 digits	±0.3°	---
400 Ω	399.99 Ω	0.5% ± 2 digits	±0.3°	Series
40 Ω	39.999 Ω	0.7% ± 2 digits	±0.4°	Series
4 Ω	3.9999 Ω	2.0% ± 2 digits	±1.2°	Series

ESR*

Frequency = 100 Hz*/120 Hz/ 1 kHz/10 kHz*

Range	Max Display	ESR Accuracy	Measurement Mode
1000 Ω	999.9 Ω	0.5% \pm 2 digits	Series
100 Ω	99.99 Ω	0.5% \pm 2 digits	Series
10 Ω	9.999 Ω	0.7% \pm 2 digits	Series
1 Ω	.9999 Ω	2.0% \pm 2 digits	Series

* = Model 879B only

MAINTENANCE

WARNING: Do not perform any service by yourself. Service should only be done by qualified personnel and trained technicians.

Service

If the instrument fails to operate, check battery and test leads. Replace them as necessary. If the instrument still cannot work, verify with the operating instructions to make sure correct procedures are followed.

When servicing, use specified replacement parts only.

Note: *The meter must be completely turned off while replacing the battery. Refer to "Installing Battery" section for details.*

Cleaning

WARNING: To avoid electrical shock or damaging the meter, prevent water from getting inside the case. In the case that water gets inside, remove the battery immediately and do not operate the instrument

immediately. Doing so will immediately damage the instrument and void it's warranty.

Before cleaning this meter, make sure the power is OFF and remove external AC adapter if one is used. To clean the meter, wipe the dirty parts with a soft cloth soaked with diluted neutral detergent. Avoid having the instrument too wet to prevent the detergent from penetrating into the inside components of the meter, causing damages. After cleaning, make sure the instrument is completely dried before operating it again.

SERVICE INFORMATION

Warranty Service: Please go the support and service section on our website [www.GlobalTestSupply.com](#) to obtain a RMA #. Return the product in the original packaging with proof of purchase to the address below. Clearly state on the RMA the performance problem and return any leads, probes, connectors and accessories that you are using with the device.

Non-Warranty Service: Please go the support and service section on our website [www.GlobalTestSupply.com](#) to obtain a RMA #. Return the product in the original packaging to the address below. Clearly state on the RMA the performance problem and return any leads, probes, connectors and accessories that you are using with the device. Customers not on an open account must include payment in the form of a money order or credit card. For the most current repair charges please refer to the service and support section on our website.

Return all merchandise to B&K Precision Corp. with pre-paid shipping. The flat-rate repair charge for Non-Warranty Service does not include return shipping. Return shipping to locations in North America is included for Warranty Service. For overnight shipments

Include with the returned instrument your complete return shipping address, contact name, phone number and description of problem.

LIMITED WARRANTY

B&K Precision Corp. warrants to the original purchaser that its products and the component parts thereof, will be free from defects in workmanship and materials for a period of three years from date of purchase.

B&K Precision Corp. will, without charge, repair or replace, at its option, defective product or component parts. Returned product must be accompanied by proof of the purchase date in the form of a sales receipt.

To help us better serve you, please complete the warranty registration for your new instrument via our website

Exclusions: This warranty does not apply in the event of misuse or abuse of the product or as a result of unauthorized alterations or repairs. The warranty is void if the serial number is altered, defaced or removed.

B&K Precision Corp. shall not be liable for any consequential damages, including without limitation damages resulting from loss of use. Some states do not allow limitations of incidental or consequential damages. So the above limitation or exclusion may not apply to you. This warranty gives you specific rights and you may have other rights, which vary from state-to-state.