



## EVCC 300

Electric Vehicle Charger Checker

*User Guide*

This manual supersedes all previous issues of this manual. Please ensure that you are using the most recent issue of this document. Destroy any copies that are of an older issue.

## **Declaration of Conformity**

Hereby, Megger Instruments Limited declares that radio equipment manufactured by Megger Instruments Limited described in this user guide is in compliance with Directive 2014/53/EU. Other equipment manufactured by Megger Instruments Limited described in this user guide is in compliance with Directives 2014/30/EU and 2014/35/EU where they apply.

# Contents

---

<b>1. Introduction</b>	<b>2</b>
1.1 Product description .....	2
1.2 Features.....	2
1.3 Applications .....	3
1.4 Company web site .....	3
<b>2. Safety Warnings</b>	<b>4</b>
2.1 Warnings, Cautions and Notes .....	4
2.1.1 Warnings .....	4
2.1.2 Cautions .....	4
2.1.3 Notes .....	4
2.2 Safety warnings.....	4
2.3 Test lead safety warnings: .....	5
2.4 Installation category definitions:.....	5
2.5 Safety, Hazard and Warning symbols on the instrument.....	6
<b>3. Instrument Overview</b>	<b>7</b>
3.1 Instrument layout.....	7
3.2 Instrument display.....	8
3.3 Instrument softkey and test button controls.....	9
<b>4. First use set up of the EVCC300 and setting</b>	<b>10</b>
4.1 Turning the instrument on and off .....	10
4.2 Battery options .....	10
4.3 Settings .....	10
4.3.1 Direct or via cable charger connection setting.....	10
4.3.2 Mains supply and touch voltage test settings.....	11
4.3.3 Language setting .....	11
<b>5. Tests</b>	<b>12</b>
5.1 Introduction.....	12
5.1.1 Correct testing sequence.....	12
5.2 Tests, PE (protective earth) touch pad test .....	13
5.2.1 Description.....	13
5.2.2 To perform the test .....	13
5.2.3 Interpreting test results.....	14
5.3 Tests, $R_{PE}$ measurement .....	15
5.3.1 Description.....	15
5.3.2 How to perform the test .....	16
5.3.3 Interpreting test results.....	17

5.4	Tests, personal protection check.....	19
5.4.1	Description.....	19
5.4.2	How to perform the test .....	20
5.4.3	Interpreting test results.....	21
5.5	Nuisance trip check.....	24
5.5.1	Description.....	24
5.5.2	How to perform the test .....	24
5.5.3	Interpreting test results.....	26
5.6	Tests, Proximity check .....	29
5.6.1	Description.....	29
5.6.2	How to perform the test .....	29
5.6.3	Interpreting test results.....	29
5.7	Tests, Control pilot and charger output check .....	30
5.7.1	Description.....	30
5.7.2	How to perform the test .....	30
5.7.3	Interpreting test results.....	32
5.8	Auto test sequence.....	33
5.8.1	Description.....	33
5.8.2	Test selection.....	33
5.8.3	How to perform the test .....	33
5.8.4	Interpreting test results.....	34
<b>6.</b>	<b>Error and Warning Conditions</b>	<b>35</b>
6.1	On screen error messages .....	35
<b>7.</b>	<b>Settings</b>	<b>36</b>
7.1	General settings.....	36
7.1.1	Description. ....	36
7.1.2	Settings menu selection .....	36
<b>8.</b>	<b>Maintenance</b>	<b>38</b>
8.1	General maintenance.....	38
8.2	Cleaning .....	38
8.3	Battery.....	38
8.3.1	Battery status .....	38
8.4	Battery and fuse replacement .....	39
<b>9.</b>	<b>Specifications</b>	<b>40</b>
9.1	EVCC specifications .....	40
9.2	Type 1 adaptor specifications .....	43
<b>10.</b>	<b>Accessories and Equipment</b>	<b>44</b>
10.1	Included accessories.....	44
10.2	Optional accessories .....	44

<b>11. Calibration, Repair and Warranty</b>	<b>45</b>
11.1 Return procedure .....	45
<b>12. Decommissioning</b>	<b>46</b>
12.1 WEEE Directive .....	46
12.2 Battery disposal .....	46
<b>13. Notes</b>	<b>47</b>

# Introduction

## 1. Introduction

---

This user guide details the operational and functional details of the Megger EVCC300 Electric Vehicle Charger Checker.

Please read this user guide fully before attempting to use the EVCC300.

### 1.1 Product description

The new EVCC300 represents a new concept in electric vehicle charger checking, providing a simple, all in one solution. The name simply means: **E**lectric **V**ehicle **C**harger **C**hecker **300** = mode 3 chargers.

The compact, ergonomically designed instrument allows the user to quickly ensure a charger is in a safe, working condition. This could be done prior to putting back into use following maintenance, or simply as a regular health check to ensure everything is safe and working as it should be.

The EVCC300 is capable of checking both the safety and operation of a mode 2 and single-phase, mode 3 electric vehicle charger and does it in a simple, easy-to-use manner.

One of the benefits of the new EVCC300 is that it not only sets control pilot conditions to allow other electrical tests or to observe the charger's reaction, it can also read the code received from the charger. The control pilot signal (CP) is then compared with the requirements of IEC 61851-1:2017, without the need for a separate oscilloscope. This makes the EVCC300 a unique solution to ensuring EV charger safety and reliability.

### 1.2 Features

The EVCC300 incorporates several grouped safety tests: protective earth integrity, nuisance tripping of an RCD or GFCI, and connection communication and charging control, as follows:

1. Safety checking tests:
  - 1.1. Protective Earth (PE) touch pad test: To detect faults such as open circuit ground connection, voltage present on ground connection and other charger supply problems.
  - 1.2. Protective conductor resistance measurement ( $R_{PE}$ )
  - 1.3. Touch voltage measurement (inherent part of any RCD / GFCI tests)
  - 1.4. Personal protection check
    - RCD / GFCI trip time measurement
2. Nuisance tripping check test:
  - 2.1. RCD / GFCI trip current measurement
3. EV charger operation checking tests:
  - 3.1. Proximity pilot (PP) check
    - Indicate connection and latching
  - 3.2. Control pilot (CP) check
    - Simulates electric vehicle (EV) control pilot (CP) states (A, B, C, D, E and F)
    - Reads back the set state from charger (CP voltage, duty cycle and frequency also displayed)
    - Displays charger maximum current available to car communication.

## 1.3 Applications

The EVCC300 can check the safety and operation of single phase mode 3 chargers with type 2 connections and type 1 connections using an adaptor supplied as standard. The instrument is perfect for use in the following situations:

- Following installation checking
- Following repairs checking
- Regular charger health checking
- Manufacturing QA checking

# Safety

## 2. Safety

---

The safety instructions given in this document are indicative of safe practice and are not to be considered exhaustive. Additionally, they are not intended to replace local safety procedures in the region where the instrument is used. If the equipment is used in a manner not specified by the manufacturer, the protection provided by the equipment may be impaired.

Apart from the battery and fuses within their respective handle and barrel compartments, there are no user replaceable parts within the EVCC300. Do not open the case.

### 2.1 Warnings, Cautions and Notes

This user guide follows the internationally recognized definition of warnings, cautions and notes. These instructions must be adhered to at all times.

#### 2.1.1 Warnings

Warnings alert the reader to hazardous situations where injury to personnel can occur. They are set in red type to make them stand out. They are placed before the item to which they relate and repeated at each applicable occasion.

#### 2.1.2 Cautions

Cautions alert the reader to situations where equipment damage may result if a process is not followed properly. They are set in bold type. They are placed before the item to which they relate and repeated at each applicable occasion.

#### 2.1.3 Notes

Notes give additional important information that will help the reader. They are not used when a Warning or Caution is applicable. They are not safety related and may be placed either before or after the associated text as required.

### 2.2 Safety warnings

These safety warnings must be read and understood before the instrument is used. Retain for future reference.

**Warning: This instrument must be operated only by suitably trained and competent people. Protection provided by the instrument may be impaired if it is not used in a manner specified by the manufacturer.**

- If this equipment is modified or used in a manner other than specified by the manufacturer, the protection provided by the equipment may be impaired.
- This equipment is not intrinsically safe and must not be used in hazardous atmospheres.
- This equipment is for indoor and outdoor use up to 2,000 m altitude. It must not be used in wet conditions or outside the specified temperature range.
- Use only the adapters provided with the instrument.
- If the equipment gets wet, turn off and disconnect, and wait for it to dry before turning back on. Clean equipment with a dry, clean cloth.
- Inspect the equipment for damage before each use. The equipment must not be used if any part of it is damaged.
- The touch-pad test must not be relied on to check protective earth integrity. It is an 'open-circuit' test and will not indicate a high impedance earth connection.
- A faulty protective earth connection to line may not be detected if the operator's finger is not in contact with the touch pad.
- Voltage measurements are not continuous and therefore must not be relied upon for safety. The test button



must be pressed to perform a one-time measurement. Use independent means to verify whether circuits are energised. Safe working practices must be observed.

- The PE (protective earth) pre-test must be carried out before any other test.
- If the PE pre-test fail, there may be high voltage present within the charging station and on the output terminals and a risk of electric shock. Other tests must not be started until the fault is investigated and rectified.
- If no voltage is present between the L and N of the terminals or between the L and N of the test connector when the instrument is connected to the charging point in charging mode, this may be because the instrument's internal fuse has blown.
- Disconnect from all other equipment before opening the fuse or battery compartments.
- Replacement fuses must be of the correct type and rating. Failure to fit the correctly rated fuse may result in a safety hazard and may cause damage to the instrument in the event of an overload.
- Use only non-rechargeable cells as specified in the instructions.
- Replacement cells must be of the type specified in the instructions. Observe the correct polarity
- No user serviceable parts are inside the equipment. Refer repairs to Megger approved service centres.
- At the end of the equipment's life dispose of it according to local regulations for recycling. Do not dispose of this equipment to landfill.

## 2.3 Test lead warnings:

- Test leads, including crocodile clips, must be in good condition, clean, dry and free of broken or cracked insulation. The lead set or its components must not be used if any part of it is damaged.

## 2.4 Measurement categories:

CAT IV - Measurement category IV: Equipment connected between the origin of the low-voltage mains supply and distribution panel.

CAT III -Measurement category III: Equipment connected between the distribution panel and electrical outlets.







CAT II - Measurement category II: Equipment connected between the electrical outlets and user's equipment.

Measurement equipment may be safely connected to circuits at the marked rating or lower. The connection rating is that of the lowest rated component in the measurement circuit.

# Safety

## 2.5 Safety, Hazard and Warning symbols on the instrument

This paragraph details the various safety and hazard icons on the instrument's outer case.

Icon	Description
	Warning: HIGH VOLTAGE, Risk of electric shock
	Caution: Refer to user guide.
	Equipment complies with current UK legislation
	EU conformity. Equipment complies with current EU directives.
	Equipment complies with current 'C tick' requirements.
	Do not dispose of this equipment to landfill.
	DOUBLE INSULATED. This instrument has double or reinforced insulation throughout.

### 3. Instrument Overview

#### 3.1 Instrument layout



Item	Description	Item	Description
1	Type 2 EV male connector	6	Test button
2	Touch voltage / PE (protective earth) test touch pad	7	Fuse compartment
3	ON / OFF button	8	4 mm socket ground / earth bond lead connection
4	Display	9	Battery compartment
5	Softkeys		

# Instrument Overview

## 3.2 Instrument display

The EVCC300 display is a 320x240 colour TFT screen.

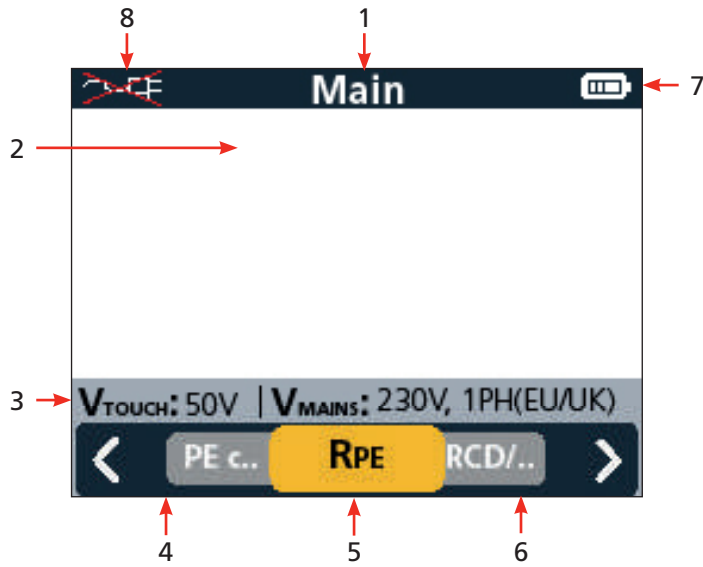

Item	Description	Item	Description
1	Screen title	5	Softkey 2 function
2	Main display area	6	Softkey 3 function
3	Supply and touch voltage settings	7	Battery condition indicator
4	Softkey 1 function	8	Charger connection setting indicator

The purpose of the main display area is to show the measurement results. The information shown in the main display area and the way it is arranged depends on the test you are carrying out and is explained in the relevant sections for each type of test.

### 3.3 Instrument softkey and test button controls

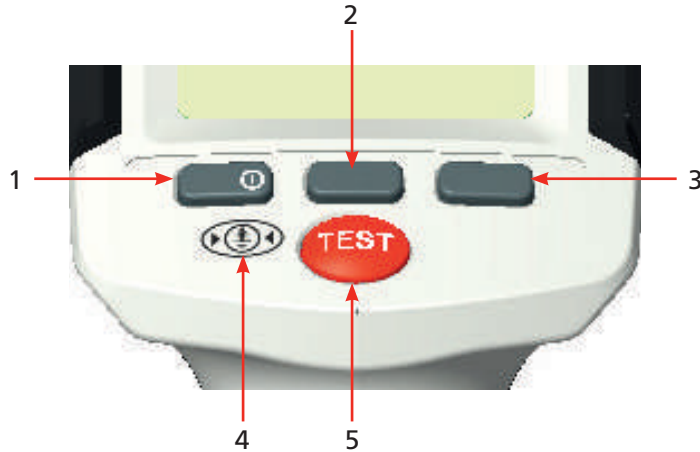

Item	Description	Item	Description
1	Softkey 1 and ON / OFF button	4	PE touch pad
2	Softkey 2	5	TEST button
3	Softkey 3		

- The softkey bar at the bottom of the screen shows the functions of the softkeys. The function of each key is shown immediately above the key itself. This function will change according to the mode selected.
- Softkey 1 is also the ON / OFF button.
  - To turn the instrument ON press this button.
  - To turn the instrument OFF, press and hold down this button for a short period. When released the instrument will turn OFF.
- TEST button - To prevent accidentally starting a test the user must hold this button down for a short period to start the test.
- Where SELECT appears the button needs to be pressed momentarily to select that test or function.
- Where BACK appears in blue, the button needs to be pressed and held for a longer period to operate moving back to the previous screen. The blue is to remind the user that a long press is required to operate.

# First use set up of the EVCC300 and setting

## 4. First use set up of the EVCC300 and setting

### 4.1 Turning the instrument on and off

1. To turn the EVCC300 ON press and hold softkey (1).
2. To turn the EVCC300 OFF press and hold softkey (1).

Before use it is important that the EVCC300 is set up correctly. The following the appropriate supply settings. There are four options as follows:

1. 230 V, 1 Ph (EU / UK)
2. 120 V, 1 Ph (US)
3. 208 V, 2 Ph (US)
4. 240 V, 2 Ph (US)

Once the initial supply settings have been set the settings will be accessed in the order shown below in section c.

### 4.2 Battery options

The EVCC300 operates from four alkaline AA battery cells.

**Warning: DO NOT use rechargeable batteries in the EVCC300**

### 4.3 Settings

#### 4.3.1 Direct or via cable charger connection setting

The EVCC has the capability to detect and test the proximity and latched status of the connection to the charger. To be able to achieve this the instrument will need to know whether it is plugged into a charger directly or via a tethered or connection cable.

When selecting settings the EVCC300 will allow the user to toggle between charger connection method:

1. Press softkey 1 or 3 (arrows) to highlight the desired setting
  2. Press softkey 2 to SELECT. When the required connection method is selected the EVCC300 will immediately return to the main menu screen.
- or
3. Select softkey 3 (NEXT) to advance to the next setting screen, Supply Settings.

This will allow a rapid change of connection method while testing. In the main menu screen there is an indicator in the top left of the screen.

In this example of a menu screen the EVCC300 is set to direct connection. If the red cross is not present the instrument is set for connection to the charger via a tethered cable or plug in charging cable.

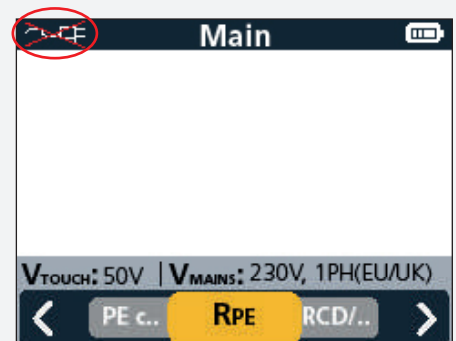
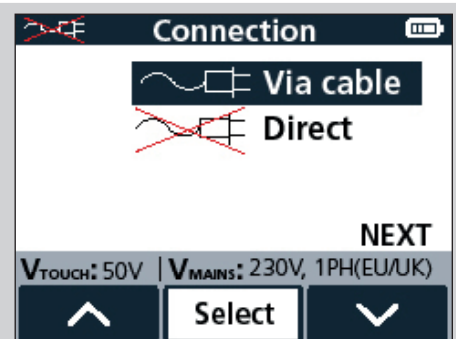

# First use set up of the EVCC300 and setting

## 4.3.2 Mains supply and touch voltage test settings

User preferred voltage options can be selected from here. Selected voltages will be saved and shown on screen in the grey ribbon at all times. These voltages can be changed at a later time if required.

1. Press softkey 1 or 3 (arrows) to highlight the desired setting
  2. Press softkey 2 to SELECT. When the required supply setting is selected the EVCC300 will immediately return to the main menu screen.
- or
3. Select softkey 3 (NEXT) to advance to the next setting screen, Language Settings.

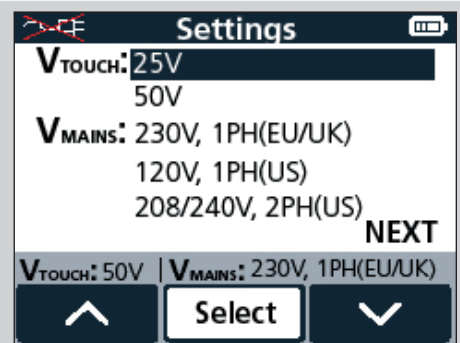

## 4.3.3 Language setting

1. Press softkey 1 or 3 (arrows) to highlight the desired setting
2. Press softkey 2 to SELECT.

When the required supply setting is selected the EVCC300 will immediately return to the main menu screen.



These settings can be changes at any time. Refer to 6. Settings on page 36

### 5. Tests

---

#### 5.1 Introduction

##### 5.1.1 Correct testing sequence

The EVCC300 incorporates effectively four safety tests (1.1 to 1.4 in the list below), one test to determine if nuisance tripping of an RCD or GFCI is likely to occur (2.1 in the list below) and two operational (charger output enabled) tests (3.1 to 3.2 in the list below) :

**Warning: It is important for safety reasons to apply these tests in the order shown below:**

1. Safety checking tests:
  - 1.1. Protective Earth (PE) touch pad test: This test can indicate a number of faults:
    - Charger is not earthed / grounded
    - Charger earth / ground has live voltage present
    - Charger is not able to output a charging voltage
  - 1.2. Protective conductor resistance measurement ( $R_{PE}$ )
  - 1.3. Touch voltage measurement (inherent part of any RCD / GFCI tests)
  - 1.4. Personal protection check
    - RCD / GFCI trip time measurement
    - This includes the DC current trip time as this is essential to ensure the AC current element of the protection remains functioning.
2. Nuisance tripping check test:
  - 2.1. RCD / GFCI trip current measurement
3. EV charger operation checking tests:
  - 3.1. Proximity pilot (PP) check
  - 3.2. Control pilot (CP) check
    - Simulates electric vehicle (EV) control pilot (CP) states (A, B, C, D, E and F)
    - Reads back the set state from charger (CP voltage, duty cycle and frequency)
    - Displays the current available being communicated to the car

**Warning: This sequence is important because it ensures the charger is safe before performing the operational tests in the charger.**



## 5.2 Tests, PE (protective earth) touch pad test

### 5.2.1 Description

This is the first test that should be performed when using the EVCC300 to test a mode 2 or 3 vehicle charger. During this test the charger is quickly powered up. If there is a ground / earth connection present the instrument will indicate PROCEED. Should there be no ground / earth connection to the charger, or a voltage present on the ground / earth the test will indicate FAULT. This test is done by using a touch pad, in conjunction with a series of voltage measurements.

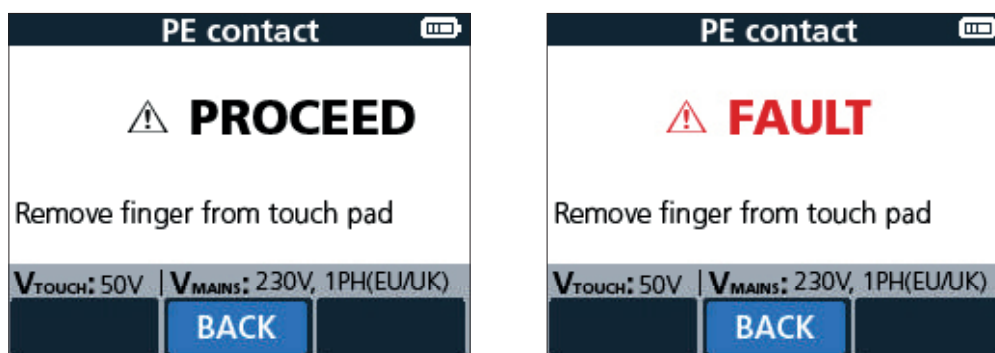

Fig 1: Pass screen

Fail screen

**NOTE:** This test is disabled when the mains supply is set to 240 V 2 Ph US. This is because this test will not work on 2 phase 180° supply.

**WARNING:** The PE contact / touch-pad test is not a bonding test and must not be relied on to check protective earth integrity. It is an 'open-circuit' detect test and will not indicate a high impedance earth connection.

### 5.2.2 To perform the test

1. Switch the instrument ON.

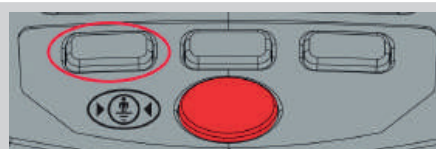

2. Ensure the mains supply to the charger is powered up and on.

3. Plug the EVCC300 into the charger outlet, either directly into a type 2 connector or using the adaptor provided into a type 1 connector.



## Tests

Ensure the connection method indicated in the top left corner of the MENU screen is correct.

As a reminder the menu screen connection indicator looks like this.

In this screen the EVCC300 is set to direct connection. If the red cross is not present the instrument is set for connection to the charger via a tethered cable or plug in charging cable.

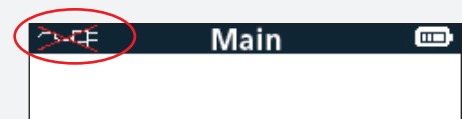

4. Use the softkeys 1 and 3 (Left and right) to select the "PE contact" test indicated in black.

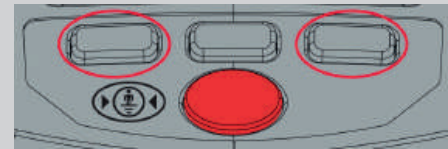

5. Press softkey 2 to SELECT the test.

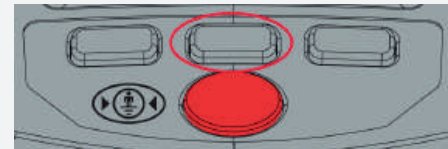

6. Firmly press a finger on the PE contact pad.

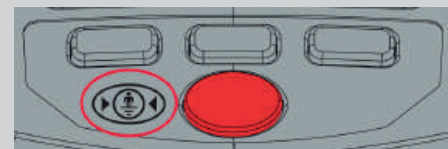

7. Press and hold the TEST button while keeping a finger on the contact pad.

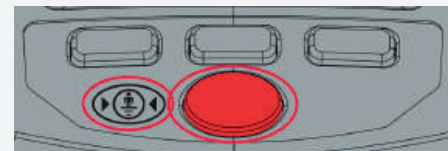

During the test the EVCC300 will apply a charging code to the charger to put it into the charging state. This is to allow the PE contact test to detect if a ground or earth connection is not present. The EVCC300 will then measure the voltages between L to N, L to PE and N to PE (referring to the plug connections) to ensure the voltages correct before progressing to the PE touch pad test. The test conditions for the voltage may be found in the specification section of this manual.

### 5.2.3 Interpreting test results

The EVCC300 uses input voltage measurements as well as touch pad to detect EV charger's PE wiring irregularity. Hence it is essential for users to place fingers on touch pad when instructed on EVCC300's screen during each PE test in order to avoid inaccurate test outcome.

- When incorrect wiring causes PE to be live such as shown below:
  - EV charger's L -> L
  - EV charger's N -> N
  - EV charger's PE -> L

**The EVCC300 will not detect this fault unless the user's finger is on the pad.**

- When an EV charger's Earth is open-circuit such as shown below:
  - EV charger's L -> L
  - EV charger's N -> N
  - EV charger's PE -> Open-circuit (>600 kΩ)

- When an EV charger's Earth is incorrectly wired to main neutral such as shown below:
  - EV charger's L -> L
  - EV charger's N -> N
  - EV charger's PE -> N

**Neither the voltage measurements nor the touch pad will detect such fault.**

Failure to follow test instructions on screen may result in hazardous PE wiring undetected.

These conditions are applicable to UK 230 V, US 120V 1 Ph and US 208 V 2 ph.

- If the EVCC300 has not detected a problem the instrument will indicate PROCEED. This means it is OK to proceed to the next tests



If the EVCC300 detects a problem the instrument will indicate FAULT



Should this occur do not proceed with further testing. The charger should be isolated from the mains supply and a qualified electrician consulted.

The fault could be caused by a number of issues, but they can be summarised as being in one of these three categories:

- Charger is not earthed / grounded
- Charger earth / ground connection has a live voltage present
- Charger is not able to output a charging voltage. The EVCC300 will apply a C code to enable charging during the test.

## Tests

### 5.3 Tests, $R_{PE}$ measurement

#### 5.3.1 Description

The second test to perform is the  $R_{PE}$  test. In this test a continuity test is performed between the ground / earth pin on the charger socket and the 4 mm socket on the bottom of the instruments handle. This test is used on chargers that have exposed metalwork to check it is connected to the ground / earth pin on the charging socket / plug.

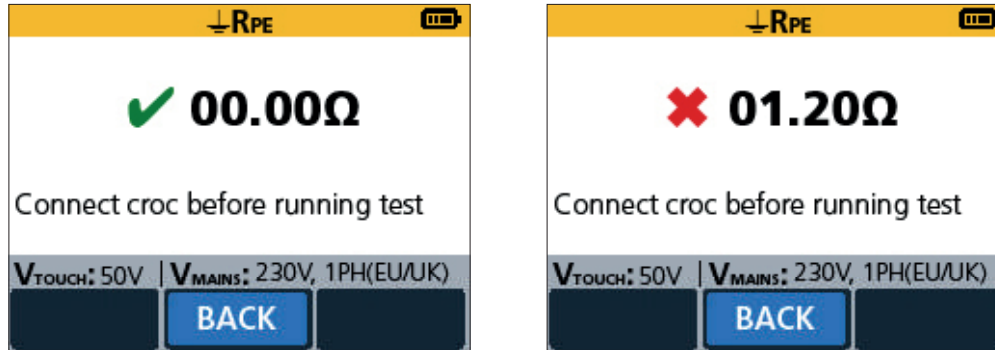

Fig 2: Pass screen

Fail screen

**NOTE:** If there is no exposed metalwork on the charger or the charger is marked with the double insulation symbol this test is not required.

**WARNING:** Ensure a PE touch test to check the integrity of the EVSE PE terminal before conducting the RPE test.

### 5.3.2 How to perform the test

1. Switch the instrument ON.

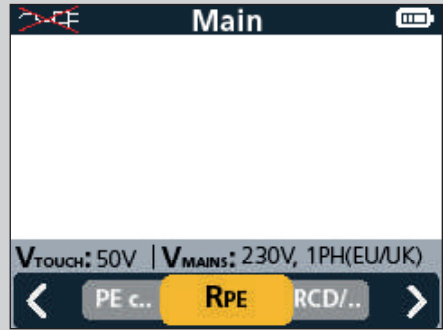

2. Connect the black ground / earth continuity test lead to the 4 mm socket at the bottom of the instruments handle.



3. Plug the EVCC300 into the charger outlet, either directly into a type 2 connector or using the adaptor provided into a type 1 connector.



Ensure the connection method indicated in the top left corner of the MENU screen is correct.

As a reminder the menu screen connection indicator looks like this.



In this screen the EVCC300 is set to direct connection. If the red cross is not present the instrument is set for connection to the charger via a tethered cable or plug in charging cable.

4. Use the softkeys 1 and 3 to select the  $R_{PE}$  test indicated in orange.

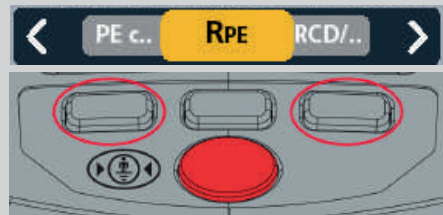

5. Press softkey 2 to SELECT test.

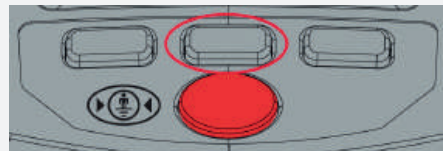

## Tests

6. Connect the crocodile clip or test probe to any exposed metal.



7. Press and hold the TEST button to start the test.



8. When the test is complete the instrument will display the results in ohms and indicate a PASS or FAIL.

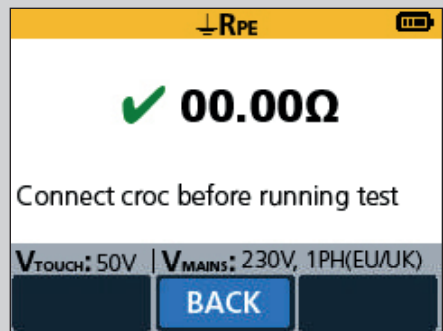

9. Move to the next piece of exposed metal on the charger and repeat the test.



10. Repeat until all exposed metal on the charger has been tested.

### 5.3.3 Interpreting test results

1. The PASS / FAIL limit on the EVCC300 has been set to 0.5 ohms
2. A green tick will indicate a PASS and the resistance will be displayed as shown



3. Should the test fail a qualified electrician should be consulted to determine the correct action



4. Should the circuit be open circuit, the results will be shown as below



# Tests

## 5.4 Tests, personal protection check

### 5.4.1 Description

EV chargers will always be protected by a residual current device (RCD) or a ground fault circuit interrupter (GFCI). Both these devices have the same functions, protecting users from electrocution and preventing fault current causing a fire. They work by detecting an imbalance in the circuit current, if less current returns from the circuit it must be flowing to ground. If this ground leakage current becomes large the RCD or GFCI will trip.

Personal protection test on the EVCC300 will apply a calibrated ground / earth leakage current matching the rating of the charger's protective RCD or GFCI device and then measure how long it takes for the device to trip. This test will check to see if the RCD or GFCI react fast enough to protect users from electrocution if a charger fault develops.

The EVCC300 can perform four different tests as follows:

#### 230 V Ph to N supply (UK / Europe tests)

- 30 mA AC, 0° and 180°
  - Test current: 30 mA + 5% = 31.5 mA
  - Max. test time: 300 ms
  - Test result: RCD trip time
- 6 mA DC, 0° and 180°
  - Test current: Ramp up at a rate of 6 mA in 2.5 s  
(to prevent test tripping AC response of the RCD)
  - Max. test time: Hold at 6 mA DC for a maximum of 12.5 s
  - Test result: RCD trip time

#### 120 V Ph to N supply (USA tests)

- 6 mA AC, 0° and 180°
  - Test current: 6 mA
  - Max. test time: 5.59 s
  - Test result: RCD trip time
- 20 mA AC, 0° and 180°
  - Test current: 20 mA + 5% = 21 mA
  - Max. test time: 5.59 s
  - Test result: RCD trip time

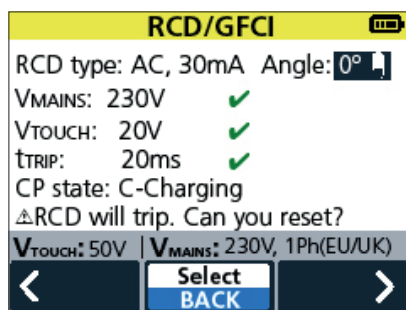
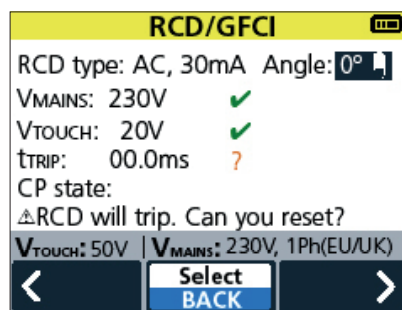
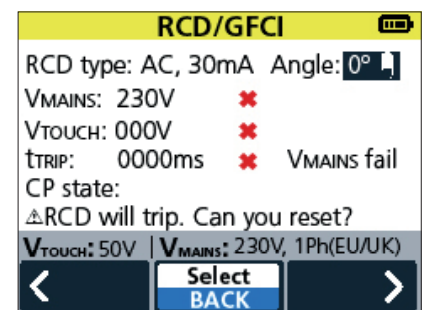

Fig 3: Pass screen



Questionable results



Fail screen



### 5.4.2 How to perform the test

1. Switch the instrument ON.

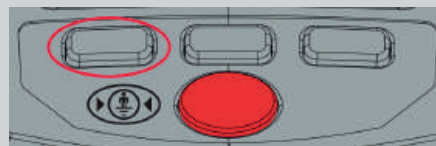

2. Ensure the mains supply to charger is powered up and on.

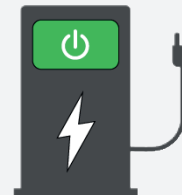

3. Plug the EVCC300 into the charger outlet, either directly into a type 2 connector or using the adaptor provided into a type 1 connector.



Ensure the connection method indicated in the top left corner of the MENU screen is correct.



As a reminder the menu screen connection indicator looks like this.

In this screen the EVCC300 is set to direct connection. If the red cross is not present the instrument is set for connection to the charger via a tethered cable or plug in charging cable.

4. Use the softkeys 1 and 3 to select the "RCD / GFCI" test indicated in green.

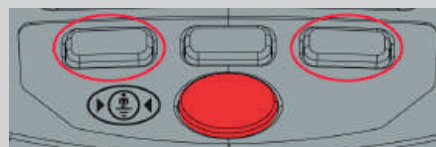

5. Press softkey 2 to select TEST.

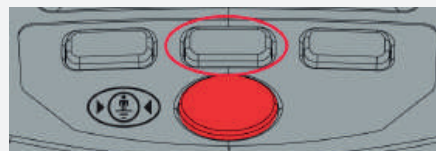

6. On the RCD test screen the left and right softkeys allow the user to highlight either the RCD Type (test type) or Angle. Press the centre select button to select which you wish to change.

7. Highlight the RCD type and then select the appropriate current under the personal protection heading "Pers. prot.:"

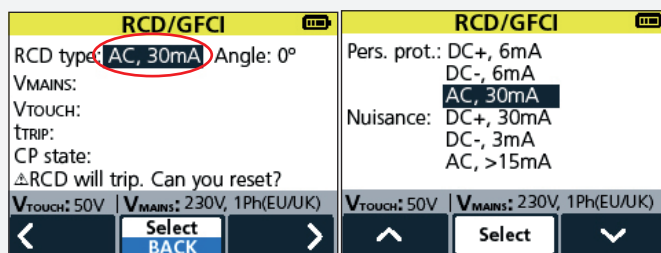

## Tests

8. The EVCC300 can perform testing with either 0° or 180° earth leakage current. This means the current flowing will either start at the positive direction zero cross over, or negative direction zero cross over.

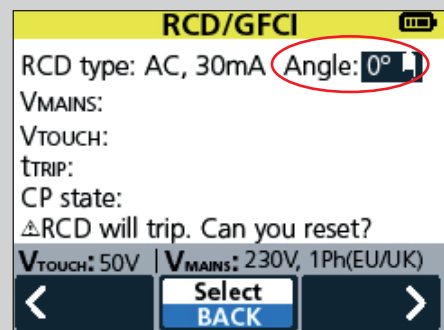

9. When the desired test has been selected press and hold the TEST button

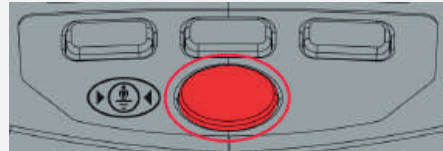

10. The test can take a while to perform. First the EVCC300 will put the charger into a charging mode and measure the output voltage.

11. The EVCC300 will then perform a touch voltage test. This is to ensure that the charger earth or ground will not raise in voltage to a hazardous level during the actual RCD / GFCI test. There are two test limits that can be applied to the touch voltage test, 25 V and 50 V. These are set in the instruments settings screen.

12. Finally, if the touch voltage test has passed the EVCC300 will perform the chosen earth leakage current test. The test result is displayed in ms.

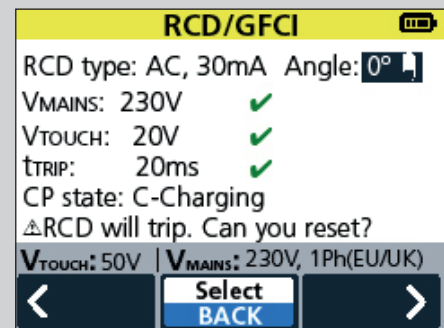

### 5.4.3 Interpreting test results

#### a. Mains (line) voltage test

Should the charger fail to switch on the output voltage the test will stop

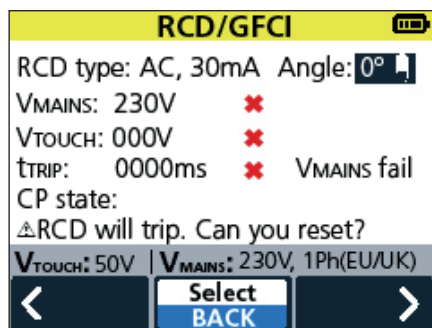

Check the charger connections and fuses

#### b. Touch voltage test

Should the touch voltage test fail this will be because the charger either has no, or a poor, connection to the PE, protective earth. Should this occur do not attempt to perform any more testing and consult a qualified electrician to determine and rectify the fault

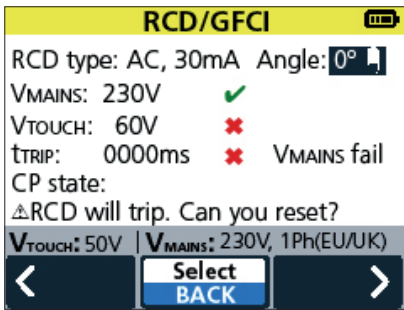

c. RCD / GFCI personal protection test result

The EVCC300 will apply pre-set test limits depending on the set mains supply and the test performed. There are three conditions that can be indicated to the user.

- (✓) Green tick – PASS
- (✓) Orange tick – Questionable
- (✗) Red cross – FAIL

A PASS result will indicate as follows:

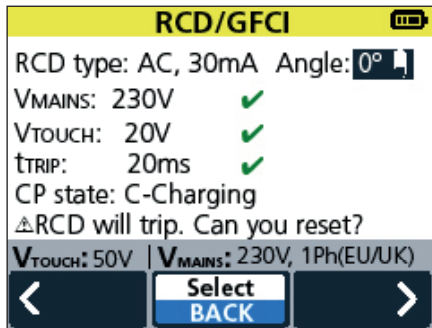

The orange, questionable result indicates that, although the trip time was fast enough to meet the requirements of a standard, it wasn't as fast as many manufacturers might recommend. In this situation it is recommended that a qualified electrician is consulted.

**Note:** Questionable test results will only occur when the EVCC300 is set to a US mains supply voltage.

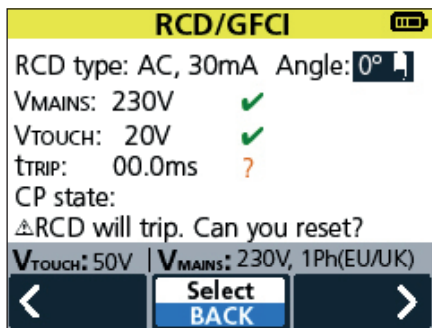

Should a red FAIL result occur the charger should be taken out of use until a new RCD / GFCI can be fitted.

# Tests

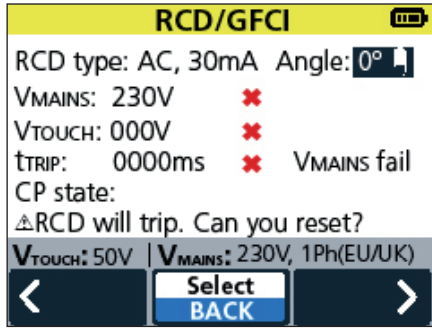

d. The criteria for the result indication is as follows:

### 230 V Ph to N (UK / Europe tests)

- 30 mA AC, 0° and 180°
  - PASS / FAIL criteria:

**PASS:** (✓)  
**FAIL:** (X)

RCD trips within 300 ms  
No RCD trip in 300 ms

- 6 mA DC, 0° and 180°
  - PASS / FAIL criteria:

**PASS:** (✓)  
**FAIL:** (X)  
**FAIL:** (X)

RCD trips between 3 mA and 6 mA and within 12.5 seconds  
No RCD trip in 12.5 seconds  
RCD trips below 3 mA (nuisance trip level)

### 120 V (USA tests)

- 6 mA AC, 0° and 180°
  - PASS / FAIL criteria:

**PASS:** (✓)  
**QUESTIONABLE:** (✓)  
**FAIL:** (X)

RCD trips within 90 ms  
RCD trips between 90 ms to 5.59 seconds  
No RCD trip in 5.59 seconds

- 20 mA AC, 0° and 180°
  - PASS / FAIL criteria:

**PASS:** (✓)  
**QUESTIONABLE:** (✓)  
**FAIL:** (X)

RCD trips within 40 ms  
RCD trips between 40 ms to 5.59 seconds  
No RCD trip in 5.59 seconds

## 5.5 Nuisance trip check

### 5.5.1 Description

EV chargers will always be protected by a residual current device (RCD) or a ground fault circuit interrupter (GFCI). These devices have the same function to protect the user from electrocution or to prevent fault current causing a fire. They work by detecting an imbalance in the circuit current, if less current returns from the circuit it must be flowing to ground. If this ground leakage current becomes too large the RCD or GFCI will trip.

The nuisance tripping test on the EVCC300 will apply a calibrated earth ground leakage current starting at approx half of the trip rating of the chargers protective RCD or GFCI device selected. The instrument will then increase the current until the RCD or GFCI trips. The result will be the actual current at which the device tripped, and is displayed in mA. Should the trip current be low this will indicate a high probability the charger will suffer from nuisance tripping of the RCD or GFCI.

The EVCC300 can perform four different tests as follows:

#### 230 V Ph to N (UK / Europe tests)

- AC current ramp test
  - Test current: Ramp up to 30 mA in 2 mA steps of 300 ms duration
  - Max. test time: 4.5 seconds
  - Test result: RCD trip current
- DC current ramp test
  - Test current: Ramp up at a rate of 6 mA in 2.5 seconds  
(to prevent test tripping AC response of the RCD)
  - Max. test time: Hold at 3 mA DC for a maximum of 11.25 seconds
  - Test result: RCD trip current

#### 120 V Ph to N (USA tests)

- 6 mA AC current ramp test
  - Test current: Ramp up to 6 mA in 0.5 mA steps of 100 ms duration
  - Max. test time: 4.5 seconds
  - Test result: RCD trip current
- 20 mA AC current ramp test
  - Test current: Ramp up to 20 mA in 1 mA steps of 100 ms duration
  - Max. test time: 2 seconds
  - Test result: RCD trip current

### 5.5.2 How to perform the test

1. Switch the instrument ON.

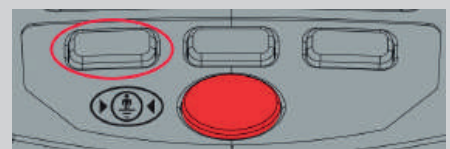

2. Ensure the mains supply to the charger is powered up and turned on.

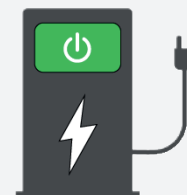

# Tests

3. Plug the EVCC300 into the charger outlet, either directly into a type 2 connector or using the adaptor provided into a type 1 connector.



Ensure the connection method indicated in the top left corner of the MENU screen is correct.

As a reminder the menu screen connection indicator looks like this.



In this screen the EVCC300 is set to direct connection. If the red cross is not present the instrument is set for connection to the charger via a tethered cable or plug in charging cable.

4. Use the softkeys 1 and 3 to select the "RCD / GFCI" test indicated in green.

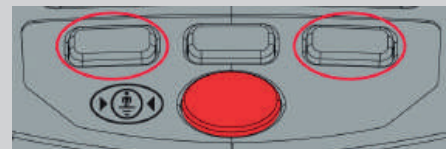

5. Press softkey 2 to select TEST.

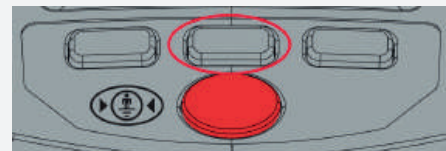

6. On the RCD test screen the left and right softkeys allow the user to highlight either the RCD Type (test type) or Angle. Press the centre select button to select which you wish to change.

7. Highlight the RCD type and then select the appropriate current under the nuisance trip heading "Nuisance:"

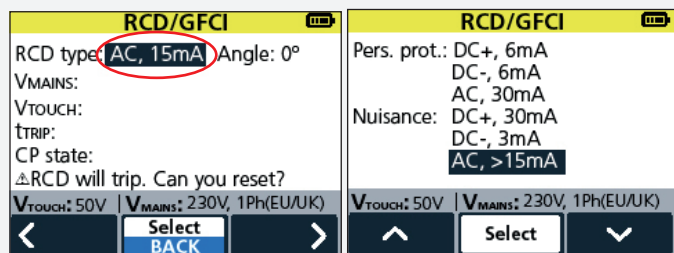

8. The EVCC300 can perform testing with either 0° and 180° earth leakage current. This means the current flowing will either start at the positive direction zero cross over, or negative direction zero cross over.

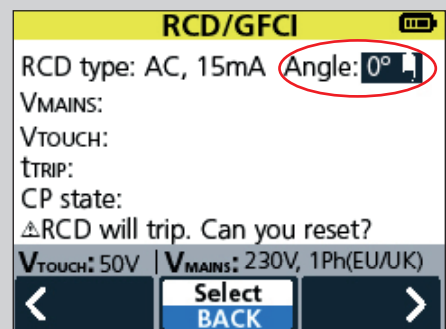

9. When the desired test has been selected long press and hold the TEST button.

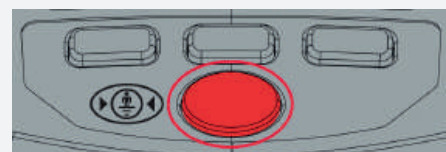

10. The test can take a while to perform. First the EVCC300 will put the charger into a charging mode and measure the output voltage.
11. The EVCC300 will then perform a touch voltage test. This is to ensure that the charger earth or ground will not raise in voltage to a hazardous level during the actual RCD / GFCI test. There are two test limits that can be applied to the touch voltage test, 25 V and 50 V. These are set in the instruments settings screen.
12. Finally, if the touch voltage test has passed the EVCC300 will perform the chosen earth leakage current test. The test result being displayed in mA.

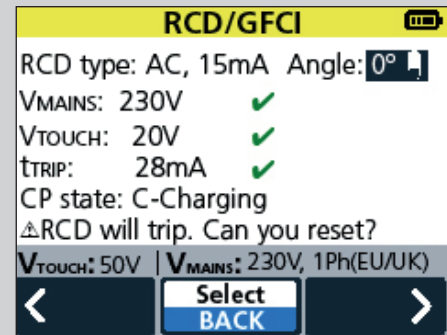

### 5.5.3 Interpreting test results

#### a. Mains (line) voltage test

Should the charger fail to switch the output voltage the test will stop

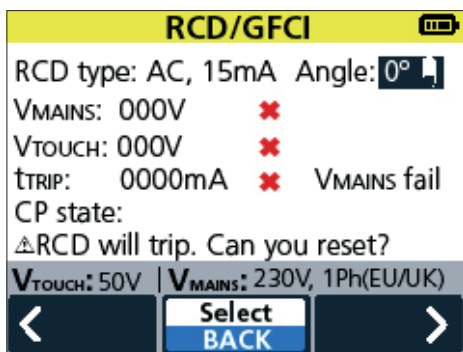

Check the charger connections and fuses

#### b. Touch voltage test

Should the touch voltage test fail this will be because the charger either has no, or a poor, connection to the PE, protective earth. Should this occur do not attempt to perform any more testing and consult a qualified electrician to determine and rectify the fault.

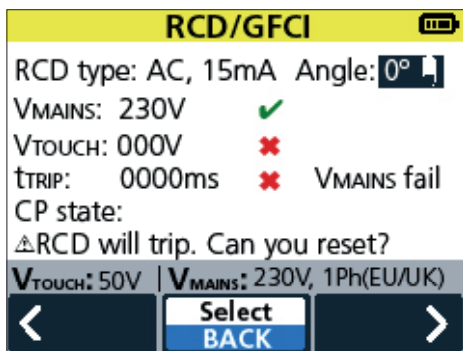



## Tests

### c. RCD / GFCI nuisance trip test result

The EVCC300 will apply pre-set test limits depending on the set mains supply and the test performed. There are three conditions that can be indicated to the user:

- (✓) Green tick – PASS
- (✓) Orange tick – Questionable
- (✗) Red cross – FAIL

A PASS result will indicate as follows:

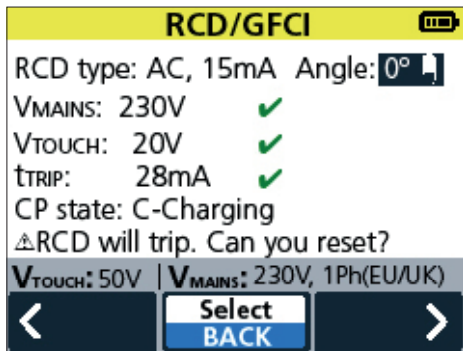

The orange, questionable result indicates that, although the trip current was of a reasonable level, it may be of a level being influenced by additional leakage or due to a over sensitive device. In this situation it is recommended that a qualified electrician is consulted.

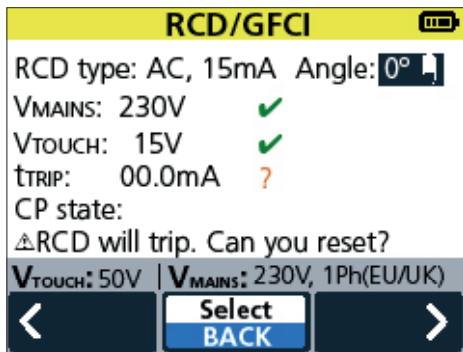

Should a red FAIL result occur the charger the trip level is of concern and will most likely result in nuisance tripping of the RCD or GFCI is use. A qualified electrician should be consulted.

### d. The criteria for the result indication is as follows:

#### 230 V Ph to N (UK / Europe tests)

- |   |                   |                                   |
|---|-------------------|-----------------------------------|
| <ul style="list-style-type: none"> <li>■ AC current ramp test           <ul style="list-style-type: none"> <li>▪ PASS / FAIL criteria:</li> </ul> </li> </ul> | FAIL: (✗)         | RCD trips between 2 mA to 14 mA   |
|   | QUESTIONABLE: (✓) | RCD trips between 16 mA to 24 mA  |
|   | PASS: (✓)         | RCD trips between 26 mA and 30 mA |
| <ul style="list-style-type: none"> <li>■ DC current ramp test           <ul style="list-style-type: none"> <li>▪ PASS / FAIL criteria:</li> </ul> </li> </ul> | FAIL: (✗)         | No RCD trip in 4.5 seconds        |
|   | PASS: (✓)         | No RCD trip                       |
|   | FAIL: (✗)         | RCD trip                          |



120 V Ph to N (USA tests)

■ 6 mA AC current ramp test

- PASS / FAIL criteria:

**FAIL:** (X)

**QUESTIONABLE:** (✓)

**PASS:** (✓)

**FAIL:** (X)

RCD trips between 0.5 mA to 3.5 mA

RCD trips between 4 mA to 4.5 mA

RCD trips between 5 mA to 6 mA

No RCD trip in 1.2 seconds

■ 20 mA AC current ramp test

- PASS / FAIL criteria:

**FAIL:** (X)

**QUESTIONABLE:** (✓)

**PASS:** (✓)

**FAIL:** (X)

RCD trips between 1 mA to 9 mA

RCD trips between 10 mA to 18 mA

RCD trips between 19 mA and 20 mA

No RCD trip in 2 seconds

# Tests

## 5.6 Tests, Proximity check

### 5.6.1 Description

Proximity circuit on the EVSE (Electric Vehicle Service Equipment) connector provides the EV with a signal so it knows it is connected to a charger. When connected the proximity signal will prevent the EV from moving. When not connected the voltage on the EV proximity pin will be 4.5 V. Once the charger is connected and the button / lever on the J1772 type 1 connector resistors in the J1772 connector will cause the voltage to drop to 1.5 V. The EVCC300 tester will check to see if this happens correctly by simulating the circuit in the EV.

In chargers that use separate connecting charging cables, the connector applies a PP resistance signal to the charger to indicate to the charger the rating of the connection cable being used. The maximum current available indicated to the vehicle via the CP signal will be adjusted accordingly. The EVCC300 can be used to check this happens correctly by testing with different rated connecting cables.

### 5.6.2 How to perform the test

The proximity circuit check is performed as part of the testing for the control pilot. Refer to 5.7.2 How to perform the test on page 31

### 5.6.3 Interpreting test results

In the top left of the EVSE interface screen next to "Prox.:" two symbols will appear. One of them indicates that proximity has been correctly detected, and the other indicates if the latch has locked on the type 1 connector.

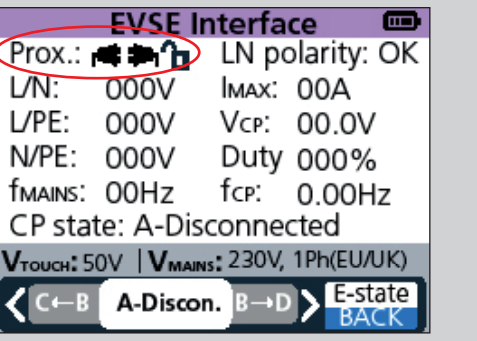
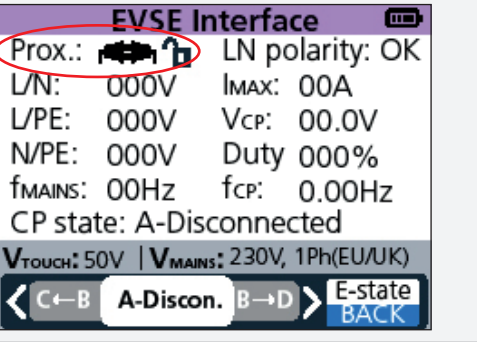
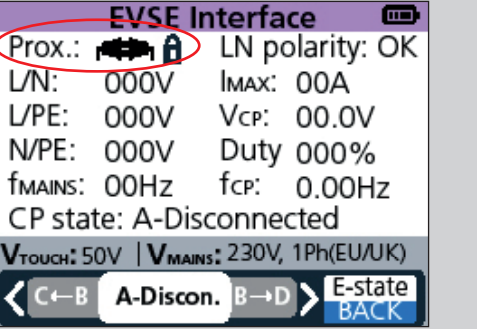
a. No proximity	
b. Proximity detected, not latched	
c. Proximity detected and latched	

## 5.7 Tests, Control pilot and charger output check

### 5.7.1 Description

The control pilot signal is the communication between the charger and the electric vehicle and cover three main areas of communication.

1. The state of the vehicle / charger
  - a. Disconnected
  - b. Connected
  - c. Charging
  - d. Charging with ventilation
  - e. CP to PE fault
  - f. Charger Fault
2. The Maximum current to be drawn by the vehicle
3. Whether digital communication indicates current

The CP signal uses a 1 kHz square wave signal with the charger state communicated using the signal voltage level. The maximum current and whether digital communication is in use is indicated by the signal duty cycle.

The EVCC300 takes the place of the vehicle and allows the user to set the desired CP code. The EVCC300 will then read the code back from the charger as set out in table A8 of IEC61851-1. This allows the user to verify the correct operation of the charger, ensuring that the charger responded as expected.

In addition, when testing the control pilot signal the EVCC300 will also measure the charger output voltage and frequency. The EVCC300 will measure the output of single phase chargers, using phase T1 only.

### 5.7.2 How to perform the test

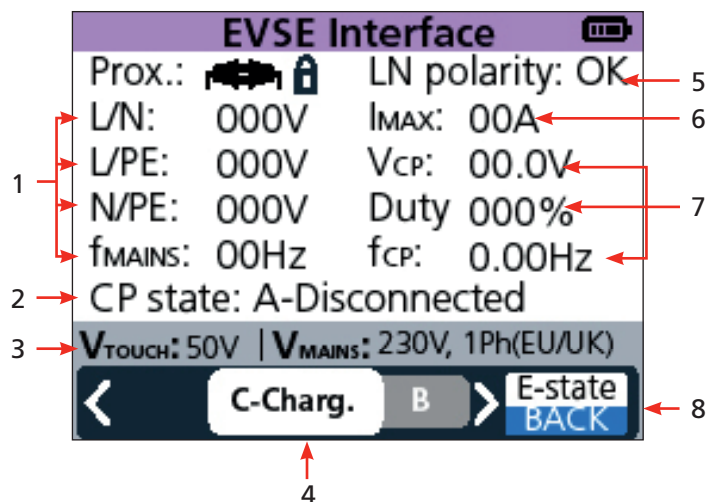

Item	Description	Item	Description
1	Charge output / mains voltage measurements	5	Polarity of charger output L to N status
2	Control pilot code read from charger	6	Maximum current available from charger
3	Touch voltage limit and mains supply setting	7	Control pilot measurements
4	Softkey 1 and 2 Set code (simulating the vehicle)	8	Softkey 3 Short press = E-state Long press = Back

# Tests

1. Switch the instrument ON

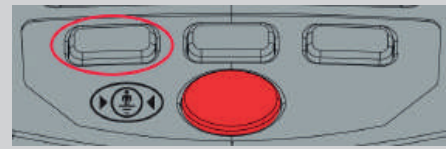

2. Ensure the mains supply to the charger is powered up and turned on

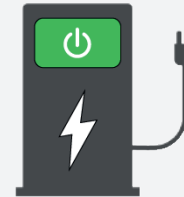

3. Plug the EVCC300 into the charger outlet, either directly into a type 2 connector or using the adaptor provided into a type 1 connector



Ensure the connection method indicated in the top left corner of the MENU screen is correct.

As a reminder the menu screen connection indicator looks like this.

In this screen the EVCC300 is set to direct connection. If the red cross is not present the instrument is set for connection to the charger via a tethered cable or plug in charging cable.



4. Use softkeys 1 and 3 (LEFT and RIGHT) to select the "Interface" test indicated in move

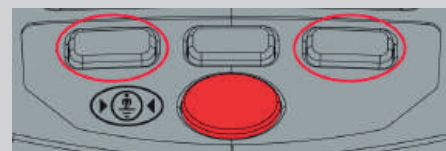

5. Press softkey 2 to SELECT the test

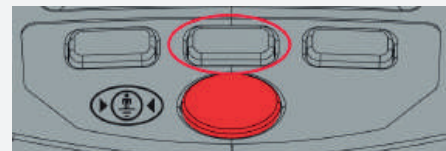

6. The EVSE Interface screen will appear

The measurements on the EVSE interface test are single measurements and are not updated continuously. After a short time warning triangles will appear next to each measurement to indicate that these measurements are held measurements and are not being updated. To update the measurements press and hold for short period the TEST button.

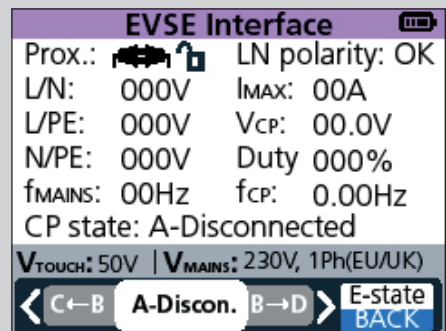

7. Press softkeys 1 and 2 to select the desired CP code applied to the charger. At this point no measurements are taken, only the CP code applied to the charger.

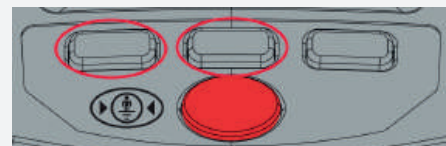

8. Press softkey 3 to set a CP short to E to test the chargers response.

At this point no measurements are taken, only the CP code applied to the charger.

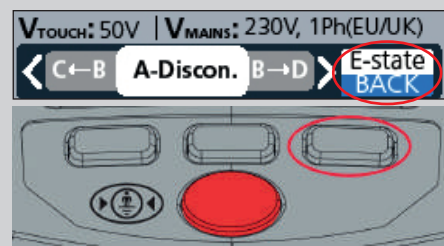

9. Press and hold softkey 3 to use the BACK function that will exit the EVSE interface screen

10. Long press the TEST button to start the test and take measurements.

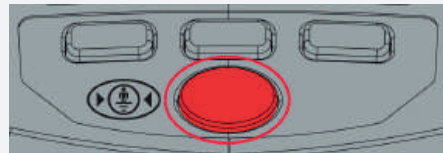

11. The test will take a few seconds to perform and measure all of the required parameters.

12. When complete the EVCC300 will also indicate the CP state measured back from the charger along the bottom of the white part of the display.

**Note** : each press of the TEST button will take one set of measurements. The test results are not a continuous measurement.

13. Re-pressing the TEST key will repeat the test measurements  
Repeating the measurements will assist in looking for stability in voltages etc.

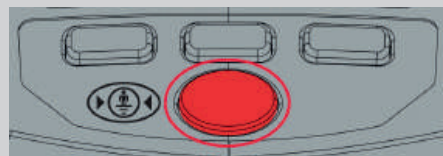

### 5.7.3 Interpreting test results

Generally the user should check that all of the measured parameters are as expected. The EVCC300 performs a single measurement of each parameter every time the test button is pressed.

1. The output charging voltages and frequency should be as expected for the type of supply the charger is connected to.
2. The polarity of the charger should read OK. If the polarity is incorrect the result will be INV.
3. The IMAX read by the EVCC300 should match what the rating of the charger is or the rating of the connecting cable used.

**NOTE:** when EVCC300 is plugged directly into a charger the PP resistance applied sets the lead rating to 32A.

4. The control pilot voltage, duty cycle and frequency measurements should be repeatable when the test is repeated.
5. The CP state read from the charger by the EVCC300 should match the code set for the test. Should the code measured be different from that set the charger indicates it is faulty.
6. Should the read back control pilot indicate a code "F – Fault" it means that there is a fault or error with the charger itself.

# Tests

## 5.8 Auto test sequence

### 5.8.1 Description

The autotest function is a great time saver. The user can select which tests they would like to perform and then the EVCC300 will run through all of the tests one by one automatically

### 5.8.2 Test selection

1. Switch the instrument ON

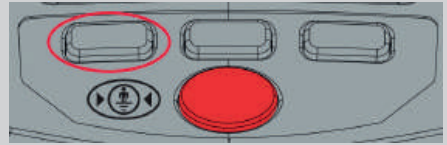

2. Use softkeys 1 and 3 to select the "AUTO" test indicated in white

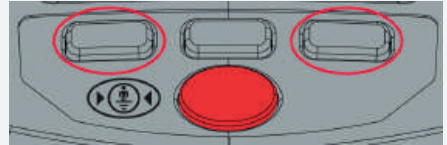

3. Press softkey 2 to select the test

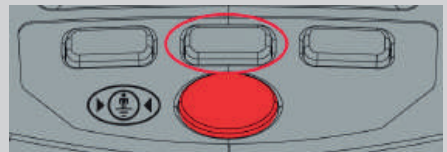

4. On the Autotest screen use the up and down softkeys (1 and 3) to highlight the test you wish to switch on or off. Tests switched on (toggle in upper position) will be performed during the autotest sequence. There are three tests you can switch on or off. These are:

a. Protective bonding (RPE)

If the charger being tested is double insulated with no external metalwork this test would not be required

b. RCD / GFCI

If you are unable to access the RCD or GDCI and therefore unable to reset it, do not perform this test. When selecting the RCD / GFCI test the user will be asked to select which test they wish to perform during the auto sequence.

c. Reset Charger

Switch on if you wish to reset the charger at the end of the autotest sequence

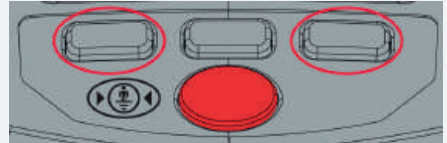

5. Use the select key to toggle the tests on or off.

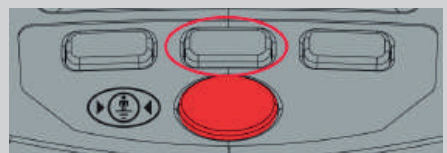

### 5.8.3 How to perform the test

1. Press and hold the TEST button to start the autotest sequence
2. The EVCC300 will perform each test in the order shown
3. Follow the instructions on the display



5.8.4 Interpreting test results

1. As each test is performed the result will simply be indicated by either a green tick (test PASS), orange question mark (test with a QUESTIONABLE RESULT) or a red cross (test FAIL)



2. As the tests proceed the result indications will appear. When performing a RCD / GFCI test the user will be prompted to reset the device following a trip test.

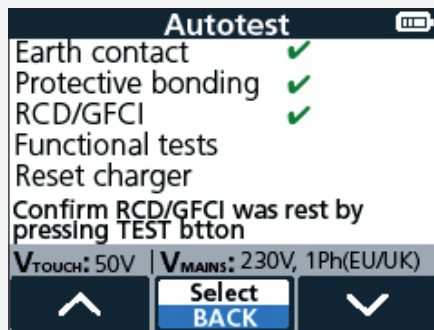

3. Should test fail, this will be indicated as follows and the test sequence will stop



4. If any of the test results are questionable this will be indicated and the test sequence will continue

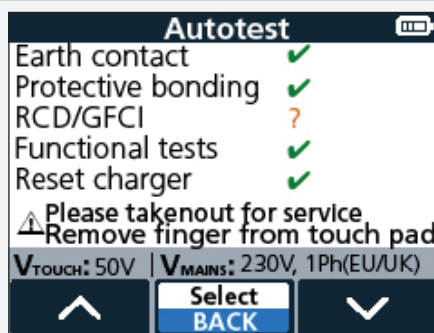

5. If the testing sequence has passed all of the test results will be ticked as follows

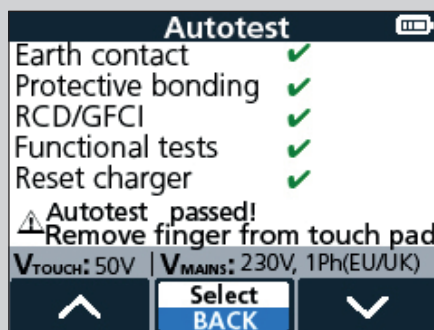

In the Autotest function none of the measurements are shown. Should a test result be indicated as questionable or fail, the user can repeat that test in the normal test screen to review the full test results.

# Settings

## 6. Settings

### 6.1 General settings

#### 6.1.1 Description.

The settings screen allows the user to select the VTOUCH test limit and the VMAINS or mains / line supply type. Prior to performing a RCD or GFCI test the instrument will perform a test to determine what the earth or ground voltage will rise to during the test. If the touch voltage is predicted to rise above the set limit the RCD or GFCI test will not go ahead. Generally 50 V is accepted as a safe limit, however the 25 V limit is usually selected if there is likely to be livestock in the vicinity.

#### 6.1.2 Settings menu selection

1. Switch the instrument ON

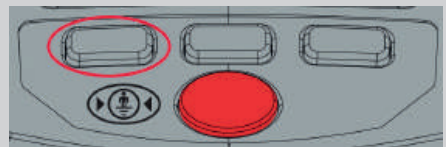

2. Press the softkeys 1 and 3 to select the "Settings" indicated in grey

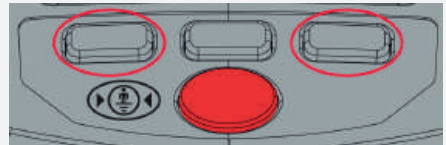

3. Press the softkey 2 to SELECT settings and the following screen will appear

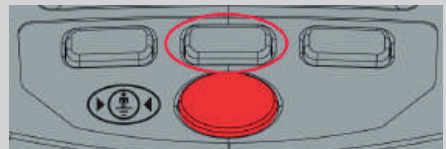

**Note:** The current instrument settings are shown in the grey bar

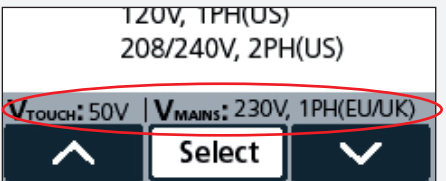

4. Press softkey 1 or 3 (arrows) to highlight the desired setting  
5. Press softkey 2 to SELECT. When the required connection method is selected the EVCC300 will immediately return to the main menu screen.

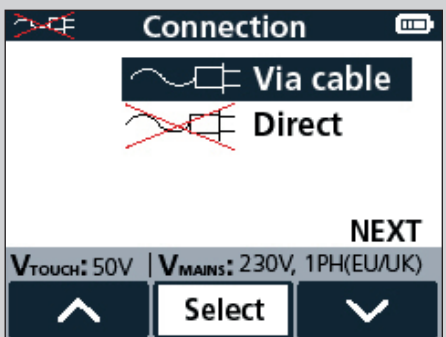

or

6. Select softkey 3 (NEXT) to advance to the next setting screen, Supply Settings.

7. New settings that are being selected are highlighted.

8. To select the desired VTOUCH voltage use softkeys 1 and 3 (UP and DOWN) to highlight the voltage limit required the

9. Press softkey 2 (SELECT) to select. The screen will return to the main display, with the new settings displayed in the grey bar

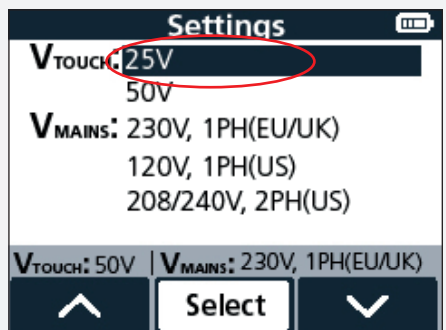



10. To select the desired mains / supply voltage select the settings screen again, highlight the required VMAINS setting and press select

11. Press softkey 1 or 3 (arrows) to highlight the desired setting

12. Press softkey 2 to SELECT.

When the required supply setting is selected the EVCC300 will immediately return to the main menu screen.



# Maintenance

## 7. Maintenance

---

**Note:** There are no user replaceable parts within the EVCC300, other than the battery cells and the fuses.

### 7.1 General maintenance

- Ensure the unit is kept clean and dry after use.
- Close all covers when not in use.
- Test leads and adaptors should be checked before use for damage and continuity.

### 7.2 Cleaning

1. Disconnect from mains power / charger.
2. Switch off and remove battery cells.
3. Wipe the instrument with a clean cloth dampened with either water or isopropyl alcohol (IPA).

### 7.3 Battery

**Warning: Always set the instrument to Off before battery cells are removed or installed.**

**Caution: Old batteries must be disposed of in accordance with local regulations.**

**Caution: Only use approved batteries as defined below.**

Battery (and fuses) are user-accessible using a screwdriver to remove access covers to the left of the grip (and to the right of the barrel respectively).

Replacement battery types are: 4 x LR6 AA Alkaline (non rechargeable). *Refer to 8. Specifications on page 40*

To help maintain the health, reliability and longevity of the installed batteries:

- Remove battery cells if the instrument is not going to be used for a long period.
- Store batteries in a cool, dry place. Batteries can be damaged when exposed to heat.

#### 7.3.1 Battery status

**Warning: Do not recharge Alkaline batteries.**

Battery condition icon is positioned at the top right hand corner of display. This icon is displayed at all times when the EVCC300 is switched on. When running the icon will indicate state of charge, the icon will be filled in proportion to the state of charge.

## 7.4 Battery and fuse replacement

**Warning:** Switch off the instrument and remove any connection before removing the battery cover.

**Caution:** Batteries should not be left in the instrument if remaining unused for an extended period.

**Caution:** Ensure the new battery cells are replaced in the correct polarity as indicated on the cells and battery compartment.

**Caution:** Ensure all battery cells are of the same type, Only Alkaline batteries are suitable to be used in the EVCC.

*Refer to 3.1 Instrument layout on page 7*

Battery cells are user-accessible using a screwdriver to remove a screw then opening the access cover on the left of the grip.

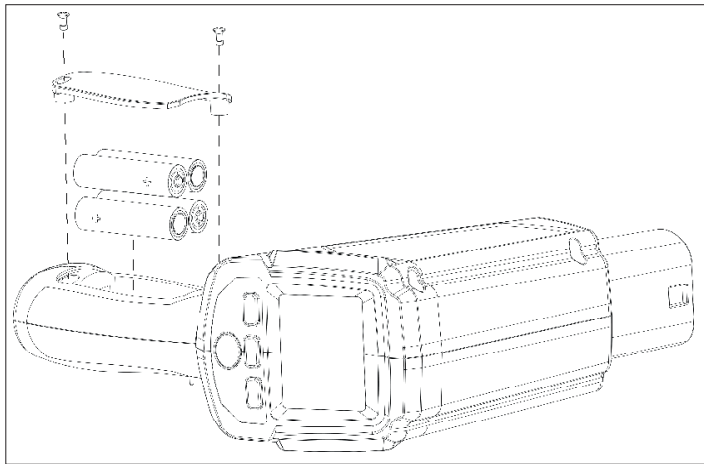

Fuses are user-accessible using a screwdriver to remove a screw then opening the access cover on the right of the main body.

# Specifications

## 8. Specifications

### 8.1 EVCC specifications

Specification	Detail
<b>ESVE STANDARD</b>	IEC 61851-1:2017
<b>ESVE SUPPLY OPTIONS (set in settings)</b>	<ol style="list-style-type: none"> <li>230 V single phase</li> <li>120 V single phase</li> <li>208 V two phase</li> <li>240 V tow phase</li> </ol>
<b>SUPPLY MEASUREMENT</b>	
Voltage range	5 V to 300 V
Voltage resolution	1 V
Voltage accuracy	$\pm 5\% \pm 2$ digits
Voltage measurement	L to N, L to PE and N to PE
Reverse polarity indication	L to N, for single phase option only
Frequency range	45 Hz to 65 Hz
Frequency resolution	1 Hz
Frequency accuracy	$\pm 1$ digit
<b>EVSE INTERFACE (EV charger function) tests:</b>	
<b>1. Proximity detection (PP) states</b>	
Read only	No proximity
	Proximity detected, unlatched
	Proximity detected, latched
<b>2. Control pilot (CP)</b>	
Set and read states:	State A – Disconnected
	State B – Connected
	State C – Charging
	State D – Charging without ventilation
	State E – CP short to PE
Read only state	State F – EVSE charger fault condition
Maximum voltage	$\pm 14$ V
Frequency range	940 Hz to 1040 Hz
Duty cycle range	8% to 97%
Maximum charging current indication according to IEC 61851-1:2017, tables A.7 and A.8	
<b>RESISTANCE OF EARTH PROTECTIVE CONDUCTOR (RPE)</b>	
Test current:	200 mA
Resistance range:	0 to 10 $\Omega$
Resistance resolution:	0.01 $\Omega$
Resistance accuracy:	$\pm 5\% \pm 2$ digits
<b>RCD/GFCI TESTS:</b>	
Trip time accuracy:	$\pm 1\% \pm 1$ ms
Trip current accuracy:	$\pm 3\%$ (apply to all RCD/GFCI tests)

<b>PERSONAL PROTECTION TESTS, 230 V SINGLE PHASE:</b>	
<b>1. RCD 30 mA AC TEST</b>	
Test current:	31.5 mA AC (5% above nominal trip current)
Max. test time:	300 ms
Polarity selection:	0° and 180° of an input sine wave
<b>2. RCD 6 mA DC TEST</b>	
Test current ramp	up at rate of 6 mA in 2.5 s, then held at 6 mA DC
Ramp polarity	positive and negative ramp
Max. test time:	12.5 s
Polarity selection:	0° and 180° of an input sine wave
<b>PERSONAL PROTECTION TESTS, 120 V SINGLE PHASE / 240 V TWO PHASE</b>	
<b>1. GFCI/CCID 5 mA AC test</b>	
Test current:	6 mA AC
Max. test time:	5.59 s
Polarity selection:	0° and 180° of an input sine wave
<b>2. GFCI/CCID 20 mA AC test</b>	
Test current:	21 mA AC (5% above nominal trip current)
Max. test time:	5.59 s
Polarity selection:	0° and 180° of an input sine wave
<b>NUISANCE TRIPPING TESTS, 230 V SINGLE PHASE</b>	
<b>1. RCD AC ramp test</b>	
Test current	AC current ramp up to 30 mA in 2 mA steps
Step time:	300 ms
Max. test time:	4.5 s
<b>2. RCD DC ramp test</b>	
Test current ramp	up at rate of 6 mA in 2.5 s, then held at 3 mA DC.
Max. test time:	11.25 s
<b>NUISANCE TRIPPING TESTS, 120 V SINGLE PHASE / 240 V TWO PHASE</b>	
<b>1. GFCI/CCID 5 mA AC test</b>	
Test current	AC current ramp up to 6 mA in 0.5 mA steps
Step time:	100 ms
Max. test time:	1.2 s
<b>2. GFCI/CCID 20 mA AC test</b>	
Test current	AC current ramp up to 20 mA in 1 mA steps
Step time:	100 ms
Max. test time:	2 s
<b>TOUCH VOLTAGE TEST</b>	
Options:	25 V or 50 V limit
Test current typically 1/3 of RCD nominal test current	

# Specifications

<b>TOUCH CONTACT PAD TEST</b>	
Conditions for the voltage measurements	
Fail conditions	
UK and EU 230 V	IF ((LE <= 0.9*230 V) and (NE >= 0.1*230 V)) OR ((LE >= 0.1*230 V) and (NE <= 0.9*230 V))
US 120 V 1Ph	IF ((LE <= 0.9*120 V) and (NE >= 0.1*120 V))
US 208 V 2Ph	IF (LE - NE >= 10 V)
US 240 V 2Ph	IF (LE - NE >= 10 V)
Pass conditions	
UK and EU 230 V	IF ((LE >= 0.9*230 V) and (LE <= 1.1*230 V) and (NE <= 0.1*230 V))
Reversed EU	IF ((LE <= 0.1*230 V) and (NE >= 0.9*230 V) and (NE <= 1.1*230 V))
US 120 V 1Ph	IF ((LE >= 0.9*120 V) and (LE <= 1.1*120 V) and (NE <= 0.1*120 V))
US 208 V 2Ph	IF ((LN >= 0.9*208 V) and (N <= 1.1*208 V) and (LE - NE <= 10 V))
US 240 V 2Ph	IF ((LN >= 0.9*240 V) and (LN <= 1.1*240 V) and (LE - NE <= 10 V))
Dangerous voltage indication at PE conductor	
<b>POWER SUPPLY</b>	
Battery:	Four AA cells Alkaline ONLY
<b>CONNECTIONS</b>	
Type 2 male – main test connection	
4 mm shrouded socket on base of handle – RPE test return connection	
<b>LANGUAGES</b>	
User interface:	English, French, German, Dutch and Spanish
User guide:	English, French, German, Dutch and Spanish
<b>DIMENSIONS AND WEIGHTS</b>	
Dimensions (L x H x W)	24 x 18 x 8.6 cm
Weight (without batteries)	583 g
<b>SAFETY</b>	
Standards	IEC 61010-1:2010
Safety category	CATII 300 V
EVSE standard	IEC 61851-1:2017
<b>ENVIRONMENT</b>	
Operational temperature	0 °C to 40 °C
Storage temperature	-10 °C to 70 °C
Operating humidity	90% R.H. at +40 °C max
Maximum altitude:	2000 m
Dust and moisture ingress:	IP40 to IEC60529 in use

## 8.2 Type 1 adaptor specifications

Specification	Detail
<b>CONNECTIONS</b>	
Type 1 female -	CAT II 300 V

## Accessories and Equipment

### 9. Accessories and Equipment

Item	Order No.
Continuity/earth bond lead	1001-233
Blow moulded case EVCC300	1014-480
EVA-T1 Type 2 to Type 1 connector adaptor	1014-481



### 10. Calibration, Repair and Warranty

---

**Megger** operate fully traceable calibration and repair facilities to make sure your instrument continues to provide the high standard of performance and workmanship that is expected. These facilities are complemented by a worldwide network of approved repair and calibration companies, which offer excellent in-service care for your **Megger** products.

#### 10.1 Return procedure

**Warning: Remove the battery cells before shipping this instrument.**

UK and USA Service Centres

1. When an instrument requires recalibration, or in the event of a repair being necessary, a Returns Authorisation (RA) number must first be obtained from one of the addresses shown above. The following information is to be provided to enable the Service Department to prepare in advance for receipt of your instrument and to provide the best possible service to you:
  - Model (for example, EVCC300).
  - Serial number.
  - Reason for return (for example, calibration required, or repair).
  - Details of the fault if the instrument is to be repaired.
2. Make a note of the RA number. A returns label can be emailed or faxed to you if required.
3. Pack the instrument carefully to prevent damage in transit.
4. Before the instrument is sent to **Megger**, freight paid, make sure that the returns label is attached or that the RA number is clearly marked on the outside of the package and on any correspondence. For items being returned outside of the UK and USA please send copies of the original purchase invoice and packing simultaneously by airmail to expedite clearance through customs. In the case of instruments which require repair outside the warranty period, an immediate quotation can be provided when obtaining the RA number.

## Decommissioning

### 11. Decommissioning

---

#### 11.1 WEEE Directive

The crossed out wheeled bin symbol placed on **Megger** products is a reminder not to dispose of the product at the end of its life with general waste.



**Megger** is registered in the UK as a Producer of Electrical and Electronic Equipment. The Registration No is WEE / HE0146QT.

#### 11.2 Battery disposal

The crossed out wheeled bin symbol placed on a battery is a reminder not to dispose of batteries with general waste when they reach the end of their usable life.

The battery, is located under the battery cover on the back of the instrument. To remove the battery follow the instructions in

For disposal of batteries in other parts of the EU contact your local **Megger** branch or distributor.

**Megger** is registered in the UK as a producer of batteries (registration No.: BPRN00142).